

DESIGN AND ANALYSIS OF MICRO-STRIP PATCH ANTENNA FOR NON-INVASIVE BLOOD GLUCOSE SENSING

Abu Hena Md. Mustafa Kamal^{1*}, Md. Tanvir Hossain² and Saleh Muhammad Maruf³

¹Assistant Professor, Department of Electronics and Communication Engineering, Institute of Science and Technology, House # 54, Road # 15/A, Dhanmondi, Dhaka-1209, Bangladesh.

²Department of Electronics and Communication Engineering, Institute of Science and Technology, House # 54, Road # 15/A, Dhanmondi, Dhaka-1209, Bangladesh.

³Assistant Professor, Department of Computer Science and Engineering, Institute of Science and Technology, House # 54, Road # 15/A, Dhanmondi, Dhaka-1209, Bangladesh.

Article Received on 02/10/2024

Article Revised on 22/10/2024

Article Accepted on 12/11/2024



*Corresponding Author

Abu Hena Md. Mustafa
Kamal

Assistant Professor,
Department of Electronics
and Communication
Engineering, Institute of
Science and Technology,
House # 54, Road # 15/A,
Dhanmondi, Dhaka-1209,
Bangladesh.

ABSTRACT

The paper focuses on the development of a novel microstrip patch antenna for non-invasive glucose sensing. The aim of this research is to design two rectangular microstrip patch antenna in CST-simulation software with the help of different dielectric constant, length, height, depth of antenna and different resonance frequency. Various operating frequency is used to find out the accurate resonance frequency to achieve better gain, bandwidth and efficiency. Two different microstrip patch antenna is created at 1.05 GHz, 2.04 GHz. The antenna is designed at a frequency of 2.4 GHz has effective variation, which is a common frequency band used in medical applications. The performance of the antenna having different substrates is analyzed on the basis of comparison of gain, directivity, VSWR, BW and return

loss.

KEYWORDS: Micro-Strip Patch Antenna, Non-Invasive Blood Glucose Sensing, CST-simulation software, Resonance Frequency, Gain, Directivity, VSWR, BW, Return Loss.

1. INTRODUCTION

Diabetes is one of the most common lifelong chronic diseases in human beings. It is mainly caused by genetic factors, immune disorders and other factors on the human body, leading to islet function decline and insulin resistance, etc., resulting in imbalance of glucose level in the body, which is manifested as failure of glucose metabolism and hyperglycemia.^[1] According to the International Diabetes Federation (IDF) Diabetes Atlas 2021, in Bangladesh, there were 8.4 million adults living with diabetes in 2019, and projected to almost double (15.0 million) by 2045. This research was conducted in line with the high urgency to no longer use invasive techniques in checking blood sugar levels. Therefore, it is necessary to design a tool that can detect blood sugar levels without injuring the body by non-invasive method.^[2] In this paper, the antenna used for blood glucose detection is micro strip patch antenna which is highly directive and flexible. The patch in micro strip antenna constructed from copper since low return loss. The choice of FR-4 material in substrate because of price and availability. Besides that, the selection of operating frequency also carried out by the comparison between different parameter of the antenna.

2. MATERIALS AND METHODS

Efficiency of microstrip patch antenna is depended on some parameters for example VSWR, Gain, Bandwidth, Return loss, Directivity etc. The shape of the micro strip patch also matters to get the different outputs. With regard to glucose sensing in particular, various methods utilizing optical or lower frequency EM waves have been examined in the past but with a detection resolution (5mg/ml) that is much lower than that required for humans. On the basis of analyzing performance we can update the older design to the newer design with better performance.^[3]

2.1 S Parameter

The electrical networks are characterized by S parameter or scattering parameter using matched impedances. In practice the most commonly quoted parameter in regards to antenna is S₁₁. S₁₁ represents how much power is reflected from the antenna hence S₁₁ is known as reflection coefficient or return loss. If S₁₁=0 dB then all the power is reflected from the antenna.

2.2 Bandwidth

The Bandwidth (BW) of an antenna refers to the range of frequencies over which the antenna can operate correctly. The antenna's bandwidth is the number of Hz for which the antenna

will exhibit an SWR less than 2:1. The bandwidth can also be described in terms of percentage of the center frequency of the band.

$$\text{Bandwidth (BW)} = \text{Upper cut off frequency} - \text{Lower cut off frequency}$$

2.3 Directivity

Directivity describes the direction of antenna's radiation pattern. If an antenna radiates equally in all direction then it has zero directionality and its directivity will be 1

$$D = \frac{4\pi}{\Omega}$$

Where, D is the directivity and Ω_{\max} is the maximum radiation solid angle.

2.4 Voltage Standing Wave Ratio

Voltage Standing Wave Ratio (VSWR) is a measurement that describes the impedance matching of the antenna to the radio or transmission line connected to it. Voltage standing wave ratio is also referred to as standing wave ratio.

$$VSWR = \frac{\{1+|r|\}}{\{1-|r|\}}$$

2.5 Antenna Model

Table 1: Dimensions of the designed rectangular microstrip patch antenna.

Parameter	For 1.05 GHz	For 2.4 GHz
W(mm)	100	80
L(mm)	100	80
L_{eff} (mm)	71.81	29.11
ϵ_{eff}	3.958	4.61
L_g (mm)	109	89
W_g (mm)	109	89

Above table shows the different parameter which is used to demonstrate two separate rectangular microstrip patch antenna. For this purposes two different operating frequency is selected.

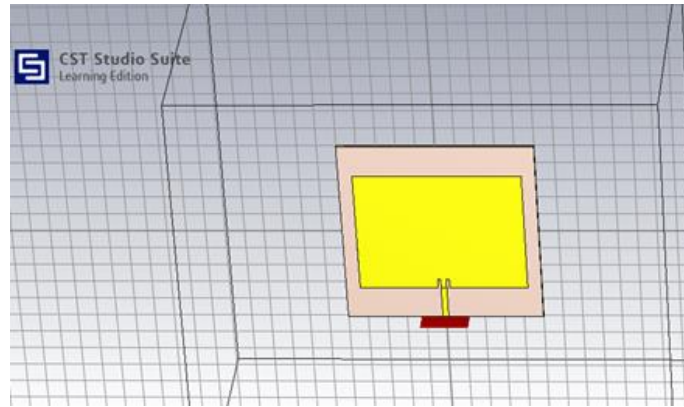

Fig. 1: Geometry of rectangular microstrip patch antenna at 1.05 GHz.

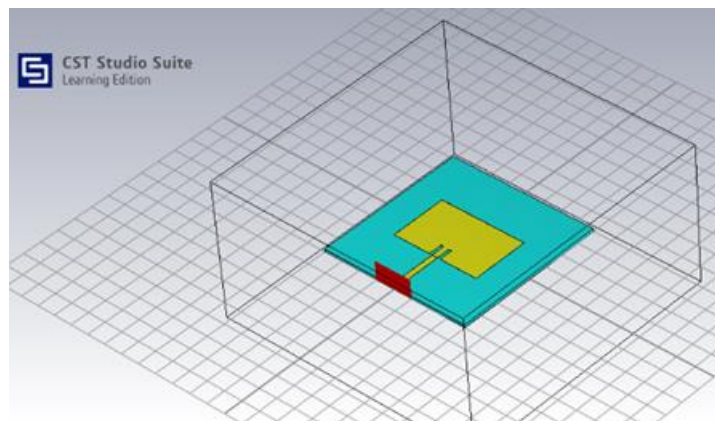

Fig. 2: Geometry of rectangular microstrip patch antenna at 2.4 GHz.

The rectangular microstrip patch antenna at 2.4 GHz and 1.05 GHz is simulated by using CST studio suite. The height of substrate at 2.4 GHz and 1.05 GHz is 1.5 mm and the dielectric constant at 2.4 GHz and 1.05 GHz is 4.08 and 4.3. For the both antenna FR-4 substrate is used.

3. RESULTS AND DISCUSSION

After simulation the return loss, gain, directivity and voltage standing ratios are calculated.

3.1 S Parameter

S Parameter is an important parameter when testing an antenna. It is related to impedance matching and the maximum transfer of power theory.^[4] S11 evaluate how much power is reflected from the antenna hence S11 is also known as reflection coefficient or return loss.

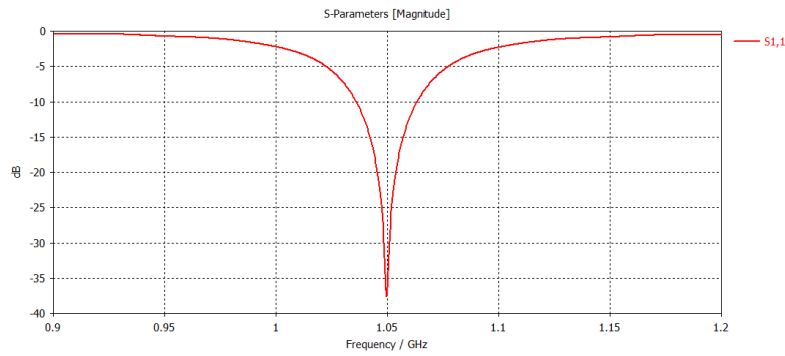

Fig. 3: S11 Parameter at 1.05 GHz.

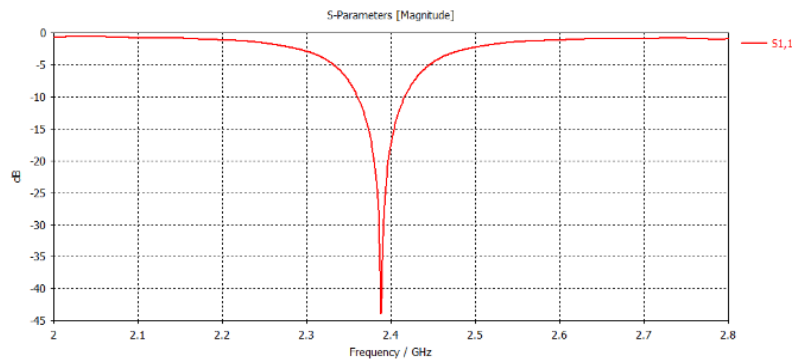

Fig 4: S11 Parameter at 2.4 GHz.

The comparison of S-parameter of the antenna having two different resonance is shown in the above figure. Figure-3 shows the resonance frequency 1.05 GHz at which return loss is approximately -37.5 dB and figure-4 demonstrated that at 2.4 GHz return loss is closely -45 dB.

3.2 Voltage Standing Wave Ratio

VSWR is a measure of how efficiently radio-frequency power is transmitted from a power source, through a transmission line, into a load.^[5]

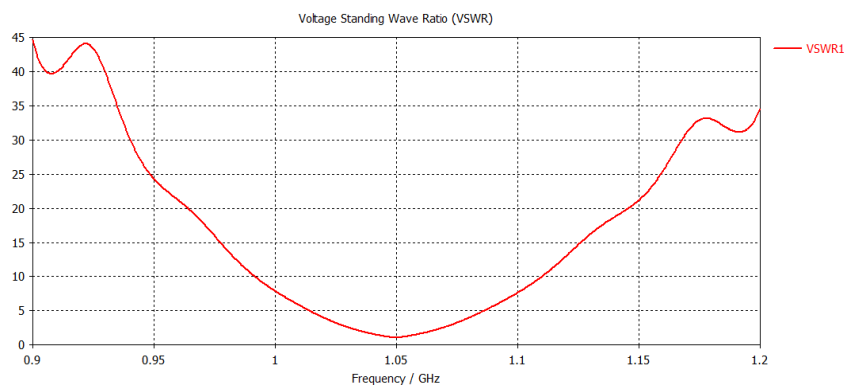

Fig. 5: VSWR at 1.05 GHz.

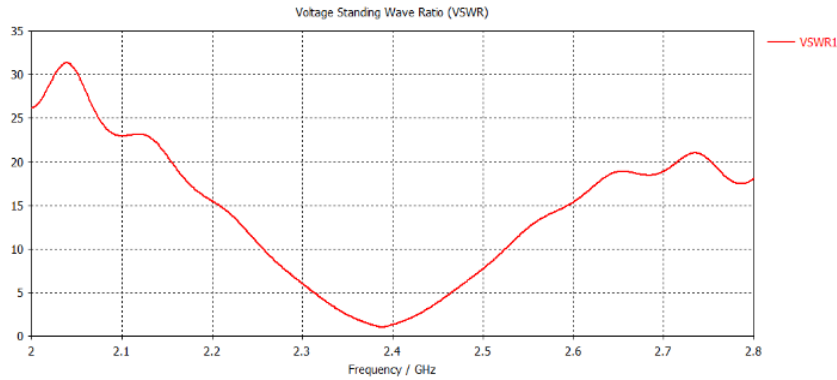

Fig. 6: VSWR at 2.4 GHz.

The Voltage Standing Wave Ratio (VSWR) versus frequency graph of the designed antenna is shown in the above figure.^[4] It also shows that VSWR of at 1.05 GHz is 0.26667 and VSWR at 2.4 GHz is 0.26667.

3.3 Directivity

Directivity explain radiated energy in a particular direction. Efficiency of an antenna mostly depend on directivity.

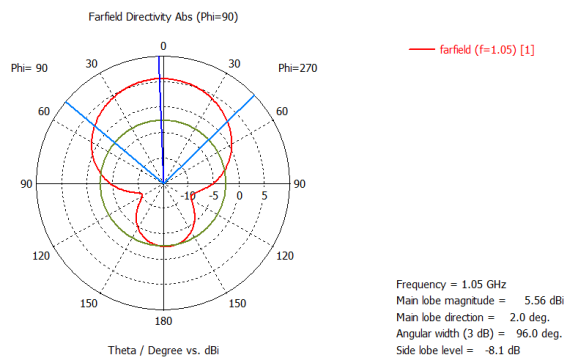

Fig. 7: Directivity at 1.05 GHz.

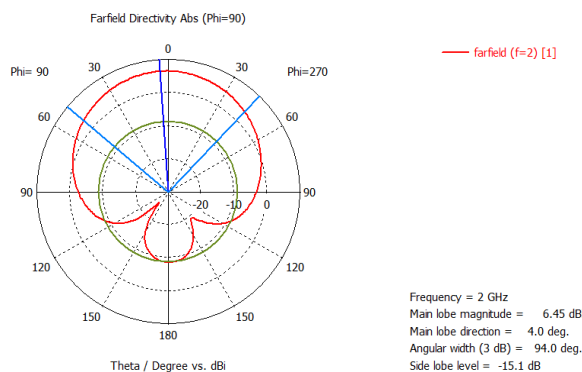

Fig 8: Directivity at 2 GHz.

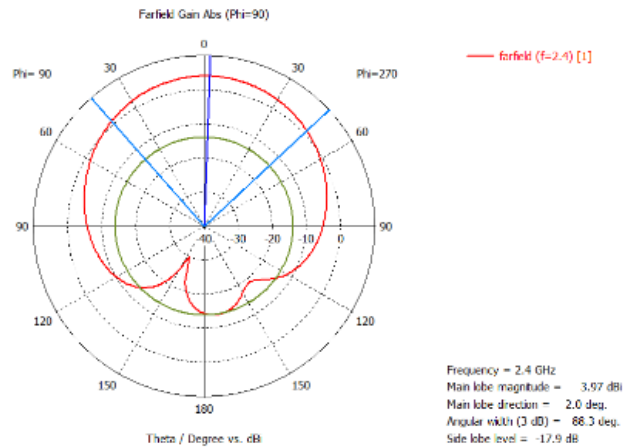

Fig. 9: Directivity at 2.4 GHz.

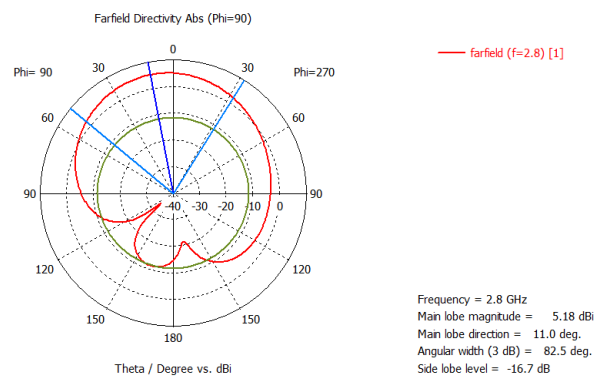

Fig 10: Directivity at 2.8 GHz.

Directivity can be evaluate from CST simulation software. Antenna having two different resonance frequency in CST can produce other frequencies directivity which is close to the operating frequency. Above figure-7, 8,9,10 shows that the directivity at frequency 1.05 GHz, 2 GHz, 2.4 GHz and 2.8 GHz is 5.56 dB, 6.45 dB, 7.1 dB and 5.18 dB respectively.

3.4 Gain

Gain is always less than directivity because efficiency is between zero and one. The directivity increases with increase in substrate thickness h and patch width w . Conversely the beam width is expected to decrease with increasing of h & w .^[5,8]

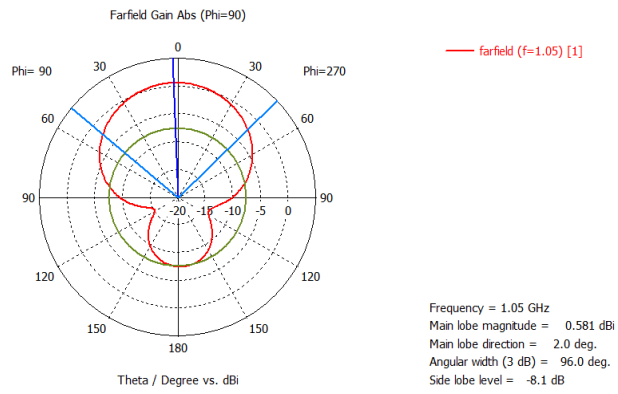

Fig. 11: Gain at 1.05 GHz.

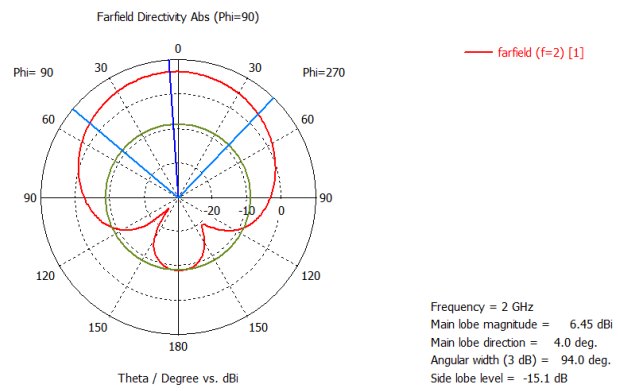

Fig. 12: Gain at 2 GHz.

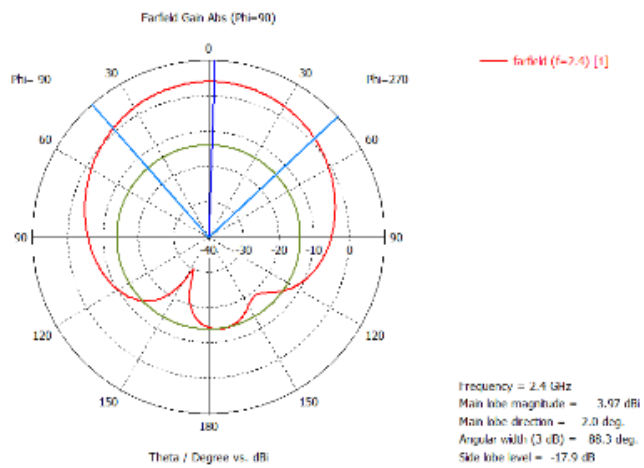

Fig. 13: Gain at 2.4 GHz.

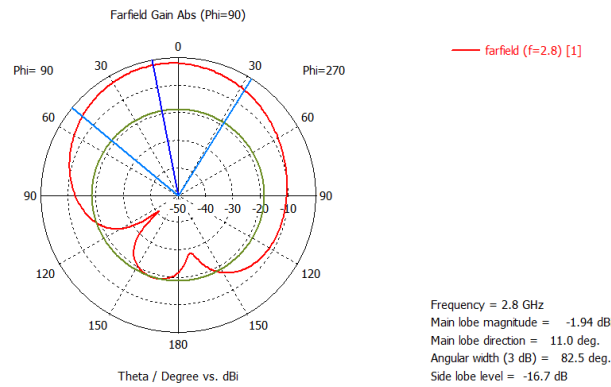

Fig. 14: Gain at 2.4 GHz.

From above figure gain is observed 0.581 dB, -0.391 dB, 3.97 dB and -1.94dB. At 2.4 GHz gain is highest compare to others.

3.5 Comparison

Table 2: Comparison of parameter at different operating frequency.

Parameter	Operating Frequency			
	1.05 GHz	2 GHz	2.4 GHz	2.8 GHz
Return Loss (dB)	-37.5	-0.6	-44	-1
VSWR	1.03105	26.19886	1.01274	18.09910
Directivity (dB)	5.56	6.45	7.1	5.18
Gain (dB)	0.581	-0.391	3.97	-1.94

Above table demonstrate the comparison of antenna parameter at different operating frequency. The criterion for selection of right antenna is its price, efficiency and size. Greater result is achieved by using operating frequency at 2.4 GHz.^[9]

CONCLUSION

This paper represents the design and analysis of rectangular microstrip patch antenna using four different resonant frequency which is 1.05, 2, 2.4 and 2.8 GHz. Also represent which resonance frequency is suitable for human glucose detection by comparison. The simulation is done by using CST studio suite. The return loss is minimum at 2.4 GHz compared to other operating frequency. The return loss for 2.4 GHz is -44 dB. The VSWR is less at 2.4 GHz compared to others. For higher efficiency both the gain and directivity is need to be high, which is happened at 2.4 GHz. The directivity at 2.4 GHz is 7.1 dB that's a good sign for glucose detection. Gain is also high at 2.4 GHz. So theoretically antenna with 2.4 GHz resonance frequency is impactful for glucose detection.

REFERENCES

1. Liu Tang, "Non-invasive Blood Glucose Monitoring Technology: A Review," Multidisciplinary Digital Publishing Institute (MDPI), 2020; 20(6925): 2-4.
2. K. Yusnita Rahayu, "Design Flexible Microstrip Antenna for Non-Invasive Blood Glucose Detection," International Conference on Radar, Antenna, Microwave, Electronics, and Telecommunications, 2022.
3. E. K. Shimul Saha, "A Glucose Sensing System Based on Transmission Measurements at Millimetre Waves using Micro strip Patch Antennas," Nature (journal), 2017; 7(6855): 1-2.
4. P. Akila, "Design and Analysis Of Microstrip Patch Antenna Using Alumina and Paper Substrate For Wifi Application," International Research Journal of Engineering and Technology (IRJET), 2018; 5(4): 3288-3289.
5. Anupam Kumar Yadav, Design and Analysis of Micro-strip patch antenna, LAP LAMBERT Academic Publishing, 2022.
6. K. G. Kiran Jain, "Different Substrates Use in Microstrip Patch Antenna-A Survey," International Journal of Science and Research (IJSR), 2014; 3(5): 1802-1803.
7. R. Gupta et al., "Performance evaluation of microstrip patch sensor for non-invasive blood glucose monitoring under varying environmental conditions," IEEE Trans. Instrum. Meas., Feb., 2022; 71(2): 1–10.
8. S. Kumar et al., "Design and optimization of a compact microstrip patch sensor for continuous blood glucose monitoring," IEEE Trans. Biomed. Circuits Syst., Feb., 2022; 16(1): 207–215.
9. A. Verma et al., "Non-invasive blood glucose monitoring using a dual-band microstrip patch sensor," IEEE Sens. J., Mar., 2022; 22(5): 6879–6887.