

THEORETICAL ANALYSIS OF INFLUENCE OF ATTACK ANGLE ON COEFFICIENT OF DRAG OF A RE-ENTRY VEHICLE USING CFD TOOLS

Pradev. D.¹, Suchith. K. S.^{2*} and Kushal Kumar G.³

¹M.Tech Final Year Student, CBIT, Kolar.

²Asst. Professor, Department of Mechanical Engineering, MVJCE, Bangalore.

³Asst. Professor, Department of Mechanical Engineering, CBIT, Kolar.

Article Received on 11/07/2016

Article Revised on 01/08/2016

Article Accepted on 22/08/2016

*Corresponding Author

Suchith. K. S

Asst. Professor,
Department of Mechanical
Engineering, MVJCE,
Bangalore.

ABSTRACT

Here, Flow simulations are carried on design configurations of Fire II re-entry capsule using CFD. Here, the purpose is to determine the coefficient of drag of a blunt shaped re-entry capsule. Here the importance of the angle of attack and its effect on the motion of re-entry capsules, especially at supersonic and hypersonic speeds is

studied, even a slight change in angle of attack can severely alter the activity of the re-entry capsule. Here we are finding co-efficient of drag of re-entry capsule for different angle of attack and hence also discussed about temperature and pressure variations around the re-entry capsule.

KEYWORDS: Re-entry capsule, CFD, Co-efficient of drag, Angle of attack.

1. INTRODUCTION

Here, the re-entry vehicle chosen is re-entry capsules, Re-entry capsules require a sphere shape fore body that will give higher aerodynamic drag and its body length is made shorter, for reducing its weight and ballistic co-efficient. Here Apollo shaped re-entry capsules are preferred rather than the using space shuttles because Apollo shaped blunt body capsules creates more drag than other re-entry vehicles. Hence, we explore the analysis on re-entry capsules.

Aim is to determine, theoretically, the co-efficient of drag of FIRE II re-entry capsules at supersonic and hypersonic speeds. Objective of the project is to perform CFD simulations on FIRE II re-entry capsules using FLUENT software, and determine co-efficient of drag for different angle of attack with different altitudes.

2. BLUNT BODY RE-ENTRY CAPSULES

Since there are many re-entry vehicles but blunt body re-entry vehicles are preferred because it creates more drag than other re-entry vehicles. The heat load experienced by a re-entry capsule was inversely proportional to co-efficient of drag. If drag is higher, heat load will be less. In blunt body shaped re-entry capsules, air does not escape easily, and air will act as cushion to move the shock waves and heated shock layers away from the capsules.

3. RELATED WORK

1. **Shiva Prasad U and Srinivas G**, carried flow simulations on re-entry bodies using fluent software and they observed the effect of aerodynamic force on motion of re-entry vehicles and characteristic features of re-entry vehicles is observed.

2. **R. Balu and L. Prince Raj**, both did analysis on re entry configurations, they compared flight measured values of two missions using CFD which shows good result of heat flux.

4. STRUCTURE OF FIRE II RE-ENTRY CAPSULE

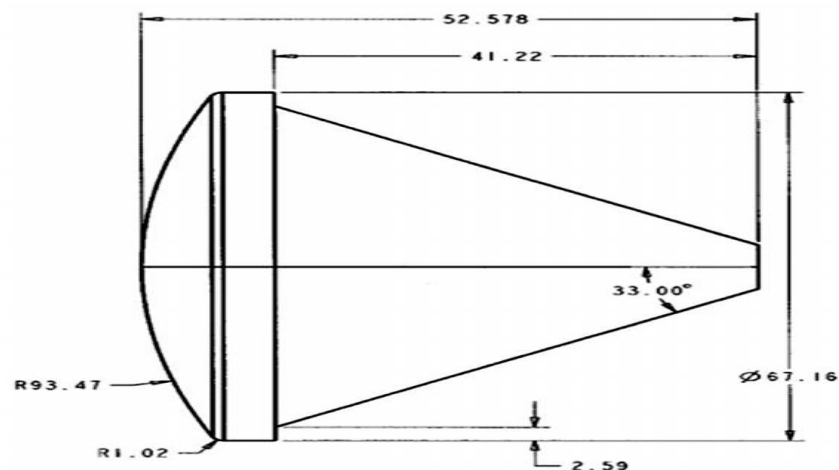

Fig 1: Structure of FIRE II re-entry capsules.

These are inexpensive than lifting ones and for direct entry they require low ballistic factor. Low ballistic factor contributes to high coefficient of drag, low mass and large area of reference.

5. MODELING OF FIRE II RE-ENTRY CAPSULE

Modeling of FIRE II re-entry capsule is done using ANSYS design modeler software, Modeling procedure is as follows.

Sketch for re-entry capsule, sketch for domain, creation of surface for sketching, subtract surface for re-entry capsule from domain, creation of name selection for pressure far field, wall facing flow, wall sides, wall after body, surface body, and face split operations are performed.

ALTITUDE (km)	TEMP (k)	PRESSURE (pa)	DENSITY (kg/m ³)	VISCOSITY (Ns/m ²)
70	217.45	4.634	7.42E-05	1.44E-05
80	196.65	0.886	1.57E-05	1.31E-05

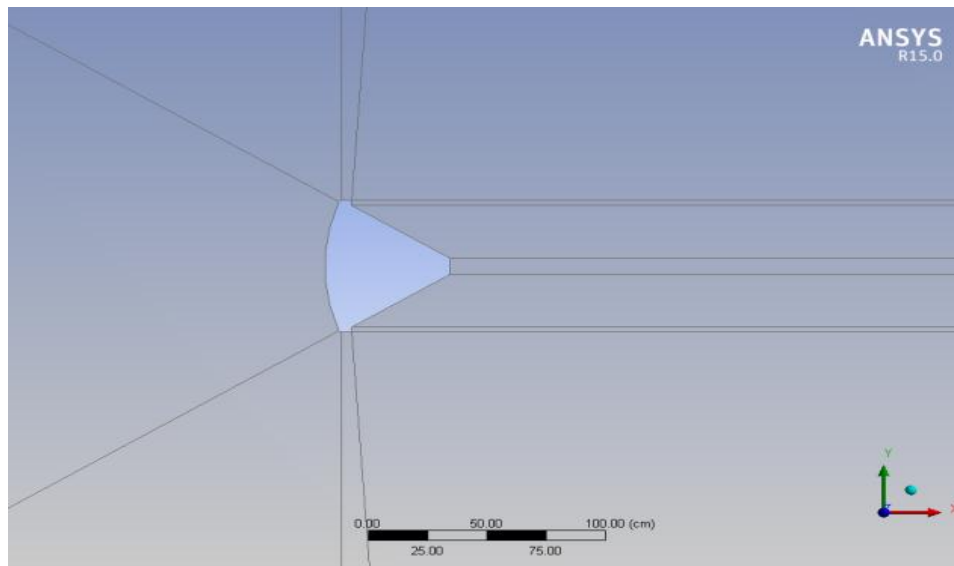

Fig 2: Close up view of modeled sketch of FIRE II Re-entry capsule.

6. MESHING

Meshing of FIRE II re-entry capsule is done using ANSYS meshing, meshing procedure is as follows.

Mesh show- mappable, Physics preference- CFD, Solver preference –FLUENT, Sizes for all edges of domain, mapped face meshing, fine mesh is obtained.

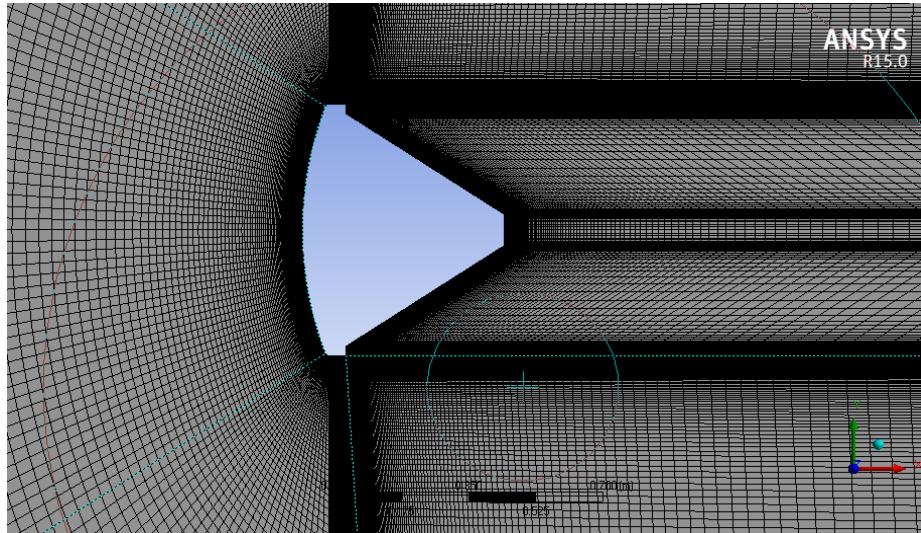

Fig 3: Meshing of FIRE II re-entry capsule.

7. BOUNDARY CONDITIONS

Following assumptions are carried out they are as follows.

- 1) Air is clean
- 2) Air is dry
- 3) Air is perfect gas mixture
- 4) Specific heat ratio, Gamma (γ) =1.4.

Table 1: Standard atmosphere properties.

Calculation of area for FIRE II re-entry capsules

$$\text{Area (A)} = \pi/4 \times (L)^2, \text{ Length(L)} = 67.16 \times 10^{-2} \text{m}$$

$$\text{Area (A)} = \pi/4 \times (67.16 \times 10^{-2})^2$$

$$\text{Area (A)} = 0.354 \text{m}^2$$

8. SIMULATIONS FOR MODEL OF FIRE II RE-ENTRY CAPSULES USING FLUENT

Here, simulations are carried out on the model of FIRE II re-entry capsule using FLUENT for different angle of attacks like 20° , 45° , 60° for 70km and 80km altitudes by applying boundary conditions as stated above.

Results are shown for 70 km altitude, 20° angle of attack at supersonic speed.

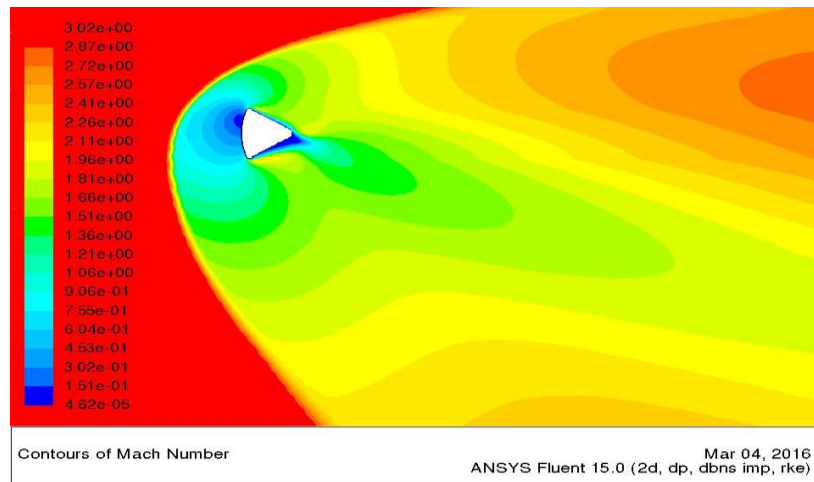

Fig 4: Contours of Mach number for 20° angle of attack and 70km altitude.

The co-efficient of drag for 20° angle of attack and 70km altitude at supersonic speed was found to be $C_d=0.966$. Figure of Contours for temperature and pressure for 20° angle of attack and 70km altitude at supersonic speeds are shown below.

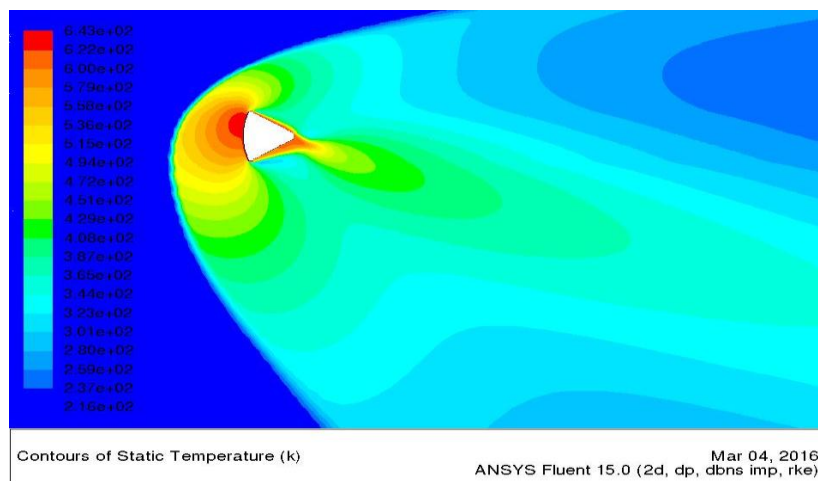

Fig 5: Contours of temperature for 20° angle of attack and 70km altitude.

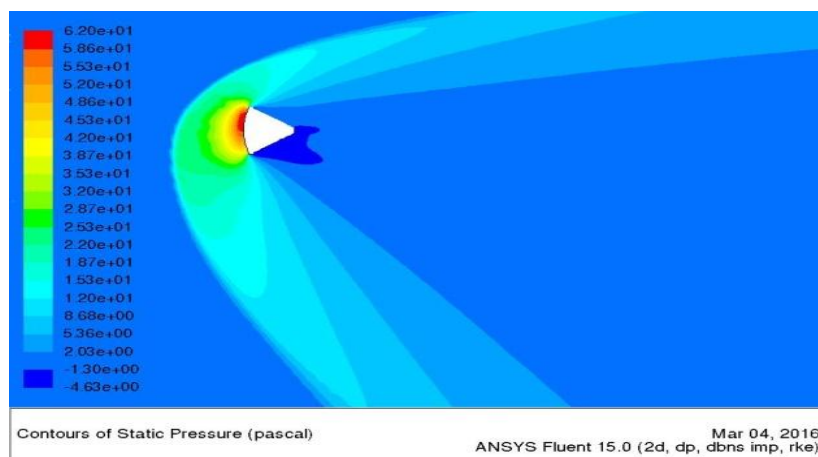

Fig 6: Contours of pressure for 20° angle of attack and 70km altitude.

9. RESULTS AND DISCUSSIONS

The following results were obtained from simulation of the model re-entry vehicle. For a given altitude, Mach number and Angle of attack, coefficient of drag is obtained as an output.

Table 2: Co-efficient of drag for different angle of attack.

Altitude (km)	Mach Number	Angle of Attack	Coefficient of Drag
70	3.0	20 ⁰	0.966
		45 ⁰	1.17
		60 ⁰	0.463
80	5.0	20 ⁰	0.801
		45 ⁰	0.994
		60 ⁰	0.419

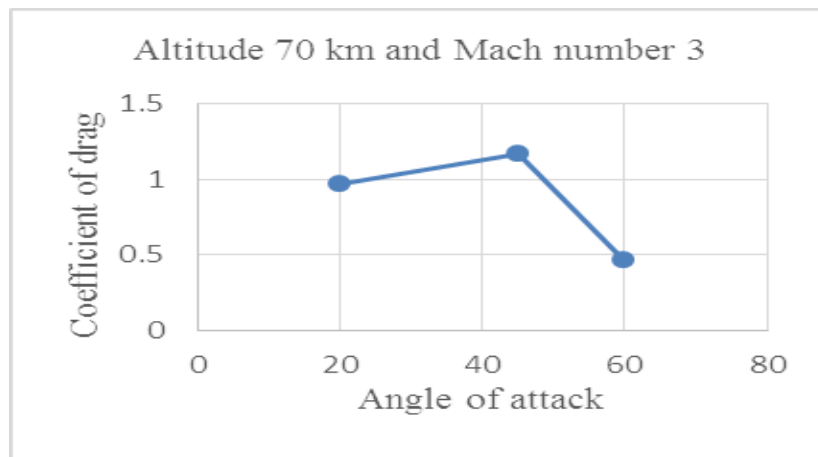

Graph 1: (a) Coefficient of drag Vs Angle of attack at an Altitude of 70km and Mach number 3.

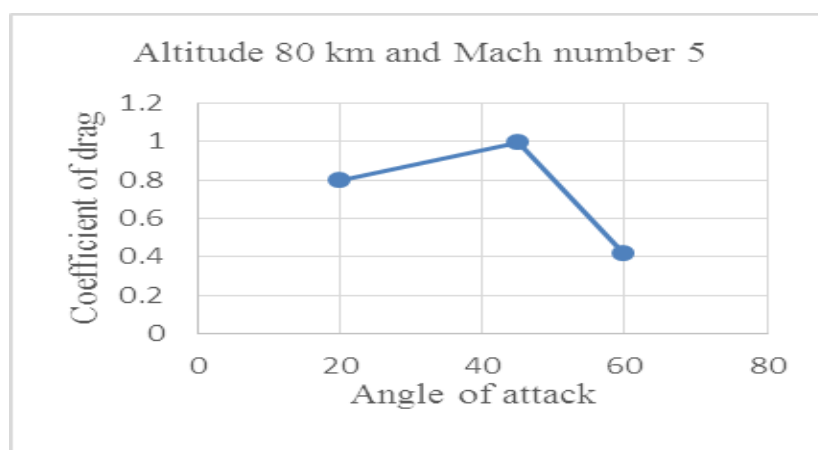

Graph 2: (b) Coefficient of drag Vs Angle of attack at an Altitude of 80km and Mach number 5.

It can be seen from the graphs 1 and 2 that, for 70 km altitude, 20⁰ angle of attack the coefficient of drag is 0.966. The coefficient of drag increases to a value of 1.17 for an attack

angle of 45° , and at 60° attack angle the drag coefficient decreases to nearly half of the value at 20° . For 80 km altitude, 20° angle of attack the coefficient of drag is 0.801. The coefficient of drag increases to a value of 0.994 for an attack angle of 45° , and at 60° attack angle the drag coefficient decreases to nearly half of the value at 20° . As it is known that the greater the coefficient of drag the lesser the speed of the vehicle; lesser speed results in relatively low friction with atmospheric air. Hence, an angle of attack that results in greater drag is desirable. The coefficient of drag at 45° angle of attack is greater than the corresponding values at 20° and 60° . Therefore, results obtained from the simulations show that the drag at 45° is maximum and from analysis it be said that an angle of attack of 45° should be considered as desirable for the said re-entry vehicle configuration.

10. CONCLUSION

1. A re-entry vehicle should be designed and should be so positioned while re-entering the Earth's atmosphere such that the coefficient of drag is maximum for the configuration.
2. Coefficient of drag is maximum at 45° angle of attack for both 70 km altitude and 80 km altitude, when compared to 20° and 60° angle of attack.
3. Greater is the coefficient of drag, the lesser is the speed of the vehicle; lesser speed results in relatively low friction with atmospheric air. Hence, an angle of attack that results in greater drag is desirable.
4. Therefore, it can be concluded that, for a maximum drag on the re-entry vehicle, the angle of attack should be 45° .

11. REFERENCES

1. Flow Simulation over Re-Entry Bodies at Supersonic & Hypersonic Speeds by Shiva Prasad U and Srinivas G, International Journal of Engineering Research and Development, 2012; 4.
2. Simulation and Optimization of Spacecraft Re-entry Trajectories by Derrick G. Tetzman., May 2010.
3. Analysis of heat transfer in hypersonic flow over re-entry configurations by R. Balu and L. Prince Raj, June 2012; 3.
4. Aero-Thermodynamic Analysis of Expert Capsule reentry Vehicle Using CFD by Narendranath Alokam, B. Dinesh Kumar, D.Muppala, International Journal of Science and Research.