

## SHAPE EFFECTS ON THE WIND INDUCED RESPONSE OF HIGH RISE BUILDINGS

Snehal A. Sawant\*<sup>1</sup> and Y.R.Suryawanshi<sup>2</sup>

<sup>1</sup>Post Graduate Student, Civil Engineering Department, JSPM's Imperial College of Engineering, and Research, Wagholi, Pune.

<sup>2</sup>Assistant Professor, Civil Engineering Department, JSPM's Imperial College of Engineering and Research, Wagholi, Pune.

Article Received on 14/03/2017

Article Revised on 05/04/2017

Article Accepted on 26/04/2017

### \*Corresponding Author

**Snehal A. Sawant**

Post Graduate Student, Civil Engineering Department, JSPM's Imperial College of Engineering, and Research, Wagholi, Pune.

### ABSTRACT

This paper will explore the shape effect of building against the wind load using design software STADD pro and the load analysis are done on the basis of FEA method. For high rise construction needs to know the expected wind loads on the building so that to work out proper resistance systems to counteract the wind loads. The present study looks to examining the wind loading patterns on various shapes of

building on direction basis. The computed wind loads are also benchmarked against standards code, IS:875-1987(part-3).In present paper the test models of G+20, G+40, G+60, G+80 with different shapes like square, rectangular, circular, Hexagonal are established and then find out their results for maximum displacement and compare software results with manual analysis.

**KEYWORDS:** FEA method, wind load, IS: 875-1987(part-3), STADD pro, maximum displacement.

### INTRODUCTION

The continuity of economic prosperity and population increase in the urban areas point toward a future with increased in activity in high rise construction of residential and office building. "In all human history we have reached 3.5 billion of urban settlers and in the next 30 years we are going to have 3 billion more". Rapid growth of population and non-

availability of land space in metropolitan cities of India has led to the unprecedented amount of construction of tall buildings. So, to accommodate this large number of world's population in the urban area there is not enough space available on the horizontal ground. To accommodate all this population only space available is in vertical space. Therefore it is mandatory to study analysis of high rise building. However, construction of high rise building can be economically attractive only if structural engineer can have comprehensive understanding of the structural behaviour of various systems on the one hand and the practical sense of the construction on the other. Two load cases are governing on high rise structure other than static load case. Earthquake load case and wind load case. Here we have concentrated on wind load case. However, the design of tall buildings is still mainly revolving around the wind loading based on the Indian wind loading standard. The design of a tall building is significantly driven by wind loading since they hinder the free flow of wind resulting in high wind forces.

However, there are also some effects of wind that can make it a friend. One example is the possible use of the building as the platform for wind turbines for generating energy. With the available wind power increasing as wind velocity cubed, the higher winds at the upper levels of tall towers present a potential opportunity to access greater wind energy than is available at ground level. There is also in principle an opportunity to use the amplified winds around tall towers to naturally ventilate the building. In hot climates the increased winds around the tower's base can, in conjunction with shading, provide opportunities to improve the thermal comfort around the building.

Shape effects, from a wind engineering perspective, have been investigated by Davenport (1971), via aerodynamic model tests. Hayashida and Iwasa (1990) also examined shape effects on super tall building using rigid models. Corner modifications and their impact on aerodynamic forces were studied in detail by Dutton and Isyumov (1990), Kawai (1998) and Tamura and Miyagi (1999) and the ASCE 7-2005.

Zhou et al. (2003) suggested that loading data accumulated via commercial wind tunnels tests of buildings in their actual surroundings could be used to supplement an overall loading database. It is encouraging to see the use of such databases for preliminary design purposes included in the commentaries of ASCE 7-05 such as <http://aerodata.ce.nd.edu/interface/interface.html>

### Wind effects on tall buildings

The wind is the most powerful and unpredictable force affecting tall buildings. Tall building can be defined as a mast anchored in the ground, bending and swaying in the wind. This movement, known as wind drift, should be kept within acceptable limits. Moreover, for a well-designed tall building, the wind drift should not surpass the height of the building divided by 500. Wind loads on buildings increase considerably with the increase in building heights. Furthermore, the speed of wind increases with height, and the wind pressures increase as the square of the wind speed. Thus, wind effects on a tall building are compounded as its height increases. Besides this, with innovations in Architectural treatment, increase in the strengths of materials, and advances in methods of analysis, tall building have become more efficient and lighter, and so, more vulnerable to deflection, and even to swaying under wind loading. Despite all the engineering sophistication performed with computers, wind is still a complex phenomenon, mainly owing to two major problems. Unlike dead loads and live loads, wind loads change rapidly and even abruptly, creating effects much larger than when the same loads were applied gradually, and that they limit building accelerations below human perception. Although the true complexity of the wind and the acceptable human tolerance to it have just begun to be understood, there is still a need to understand more the nature of wind and its interaction with a tall building, with particular reference to allowable defections and comfort of occupants.

### Vortex-shedding phenomenon

Along wind and across wind are two important terms, used to explain the vortex-shedding phenomenon. Along wind or simply wind is the term used to refer to drag forces. The across wind response is a motion, which happens on a plane perpendicular to the direction of wind. When a building is subjected to a wind flow, the originally parallel wind stream lines are displaced on both transverse sides of the building (Fig 1), and the forces produced on these sides are called vortices.

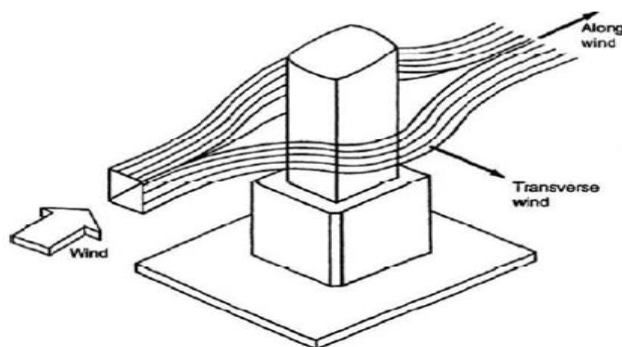
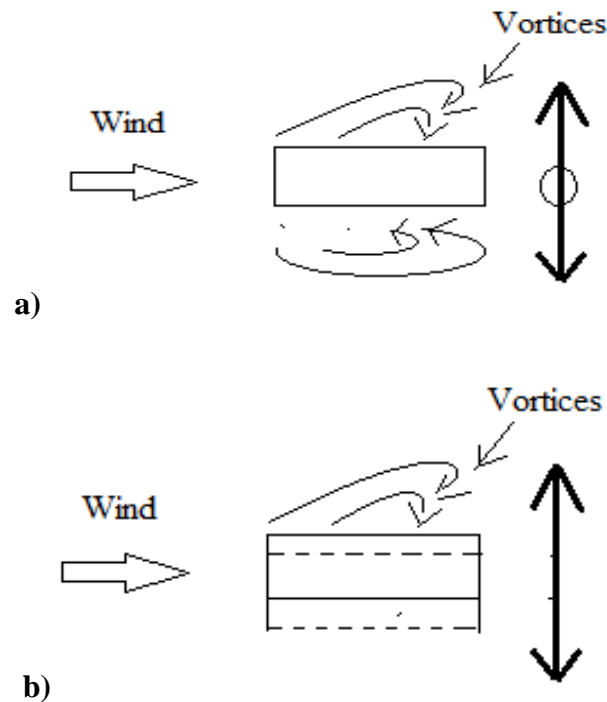

Fig 1: Simplified wind flow.

At quite a low wind speeds, the vortices are shed symmetrically on either transverse side of the building (Fig 2 a), and so building does not vibrate in the across wind direction.



**Fig 2: Vortices in different wind speed conditions.**

(a) Vortices in low speed of wind (there is no vibration in the across wind direction); (b) vortices in high speed of wind – vortex-shedding phenomenon (there is vibration in the across wind direction) On the other hand, at higher wind speeds, the vortices are shed alternately first from one and then from the other side. When this occurs, there is an impulse both in the along wind and across wind directions. The across wind impulses are applied to the left and then alternatively to the right. Therefore such kind of shedding which causes structural vibrations in the flow and the across wind direction is called *vortex-shedding*, a phenomenon well known in fluid mechanics. This phenomenon of alternate shedding of vortices for a rectangular tall building is shown schematically in Figure 2b.

These effects are heavily dependent on shape. Hence the current trend towards considering the aerodynamics of the shape very early in the design of the very tall towers. The curtain wall loads also tend to increase with height primarily due to the fact that wind speeds in general increase with height, and the winds at ground level and on terraces or balconies are increased.

## LITERATURE REVIEW

Brief review of literature relevant to the study is presented below.

1. Anupam Rajmani and Priyabrata Guha (2015) had done analysis of wind and earthquake load for different shapes of high rise building. According to Authors flexible buildings are very sensitive to wind excitation to the building occupants. Therefore, in order to mitigate such an excitation and to improve the performance of tall buildings against wind loads and earthquake loads, many researches and studies have been performed. Early integration of aerodynamic shaping, wind engineering considerations, and structural system selections play a major role in the architectural design of a tall building in order to mitigate the building response to the wind excitations. In this research work author studied four different shaped buildings namely circular, rectangular, square and triangular. It is difficult to develop simple general rules for the preference of shapes as a tool for reducing wind related problems.

There results shows that the wind tunnel testing is usually the best way for determining project specific wind loads and building motions. For 15 storied building the most stable structure is circular shape and triangular shape for maximum earthquake and maximum wind load respectively, similarly for 30 storied building, rectangular shape is most stable for maximum earthquake and wind load and for 45 storied building circular shape and rectangular shape is most stable for maximum earthquake and wind load respectively. In terms of maximum  $M_z$  triangular Shape for 15 storey, rectangular shape for 30 storeys and circular shape for 45 storey buildings are most stable respectively. In terms of maximum  $F_y$  Rectangular shape for 15 storeys, circular shape for 30 storeys and rectangular shape for 45 storey buildings are most stable respectively.

2. Ritu Raj and Ashok Kumar Ahuja (2013) carried out an experimental investigation on Wind Loads on Cross Shape Tall Buildings with varying cross-sectional shapes, but with equal floor area, in an open circuit boundary layer wind tunnel to measure wind forces acting on them. In This study they describes details about the cross-sectional shapes considered, model material and dimensions, testing procedure and observed that base shear, base moments. From results they concluded that Wind load on a building is maximum when it has maximum exposed area and wind loads get modified with wind incidence angle. Also cross-sectional shape of the building influence the wind loads acting on the building to a great extent, even if the floor area of the buildings are kept the same for all buildings. The percentage increase in the values of these forces as compared to square section depends upon

cross-sectional shapes of the buildings and twisting moments developed due to wind loads are not only influenced by wind directions, but also highly affected by cross-sectional shapes.

3. Ning Lin et al (2005) was tested the nine models with different rectangular cross-sections in a wind tunnel to study the characteristics of wind forces on tall buildings. In their study local wind forces on tall buildings are investigated in terms of mean and RMS force coefficients, power spectral density, and spanwise correlation and coherence.

From their study they observed the effects of three parameters, elevation, aspect ratio, and side ratio, on bluffbody flow and thereby on the local wind forces. They discussed that Side ratio  $D=B$ ; 0.63, greatly influences the bluff-body flow and the wind loads. At this critical side ratio, mean and RMS drag coefficients, peak of crosswind spectrum, and the crosswind cross-correlation attain their maximum values. Above the critical side ratio, these values will be reduced due to the shear-layer–edge interaction and further reattachment. The variation of the shear-layer–edge interaction along elevation levels is responsible for the variation of crosswind spectra, torsional spectra, and the spanwise cross-correlation of these two force components. Torsional spectrum and torsional cross-correlation are very sensitive to all of the three parameters. Also the overall loads and base moments are obtained by integration of local wind forces. Comparisons are made with results obtained from high-frequency force balances in two wind tunnels.

4. J. A. Amin and A. K. Ahuja (2014) founded the Characteristics of wind forces and responses of rectangular tall buildings to them and the results of wind tunnel tests on rectangular building models having the same plan area and height but different side ratios of 1, 1.56, 2.25, 3.06 and 4. The wind pressure coefficients on all the models were evaluated from pressure records measured in a closed circuit wind tunnel under boundary layer flow for wind directions of  $0^0$  to  $90^0$  at an interval of  $15^0$ . The mean responses of rectangular tall buildings having different side ratios were also evaluated from the experimentally obtained wind loads.

There results shows that the side ratio of buildings significantly affects the wind pressures on leeward and sidewalls, whereas wind pressure on windward wall is almost independent of side ratio. Further, the wind incidence angles and side ratio of the buildings significantly affect its mean displacements as well as torque. Wind pressure distribution on windward wall of rectangular models is almost independent of its side ratio at  $0^0$  wind incidence angle. As

the side ratio approaches to about 3.0, the final steady reattachment of the flow takes place on side faces at  $0^\circ$  wind incidence angle. However, side ratio has little influence on the variation of wind pressures along the vertical direction. As the side ratio of building increases, the displacement of building along the X-axis decreases and along the Z-axis increases at  $0^\circ$  and  $90^\circ$  wind incidence angles respectively. As the side ratio of building increases, the torque developed due to uneven mean pressure distribution around the building walls also increases. The eccentricity between resultant wind force and center of stiffness (and also the torque) is larger when the wind is nearly parallel to the long axis, than when it is nearly parallel to the short axis.

### OBJECTIVE

- To explore the effect of building shape on wind induced response of structure through FEM analysis.
- To provide base line values for wind load, computed response against the value given in IS 875 (1987)
- To illustrate base load comparison how certain building shape performs in wind loads.
- To analyze the different shapes and their effects on building by using design software.

### METHODOLOGY

Methodology for the present study is as follows:

#### 1. Material Properties

- Density of concrete= $25\text{kN/m}^3$
- Density of steel= $7850\text{ kg/m}^3$
- Grade of concrete= $M_{30}$
- Grade of steel= $Fe415$
- Typical storey height = 3m.
- Typical plinth height =0.9m.
- In X-direction-5 Bays of 5m @25m
- In Z-direction- 5Bays of 5m @25m

**Table 1: Parametric values of building.**

Storey No.	Shape	Beam Size (mm)	Column Size (mm)	Slab Thk (mm)	Basic Wind Press. (m/sec)
G+20	Square	500x230	450x450	120	47
	Rectangular	500x230	450x450	120	47
	Circular	500x230	450x450	120	47
	Hexagonal	500x230	450x450	120	47
G+40	Square	500x230	450x450	120	47
	Rectangular	500x230	450x450	120	47
	Circular	500x230	450x450	120	47
	Hexagonal	500x230	450x450	120	47
G+60	Square	500x230	450x450	120	47
	Rectangular	500x230	450x450	120	47
	Circular	500x230	450x450	120	47
	Hexagonal	500x230	450x450	120	47
G+80	Square	500x230	450x450	120	47
	Rectangular	500x230	450x450	120	47
	Circular	500x230	450x450	120	47
	Hexagonal	500x230	450x450	120	47

## 2. Loading Consideration

i) **Dead load case-** As per IS 875 -1987(Part-1)

ii) **Live load case-**As per is 875-1987(Part-2)

iii) **Wind load case-** The IS 875-1987(part-3) deals with wind loads to be considered when designing building, structure and components thereof,

### a) Basic wind speed ( $v_b$ )

IS 875(part-3), Fig. 1 gives basic wind speed map of India, as applicable to 10m height above mean ground level for different zones of the country. For the present study as per terrain category II basic wind speed taken as 47m/s

### b) Design wind speed ( $v_z$ )

It can be mathematically expressed as follows

$$V_z = v_b * k_1 * k_2 * k_3$$

$V_b$  =Design wind speed at any height  $z$  in m/s.

$K_1$ =Probability factor (risk coefficient)

$K_2$ =Terrain, height and structure size factor and

$K_3$ =Topography factor



### c) Design wind pressure (Pz)

The design wind pressure at any height above mean ground level shall be obtained by the following relationship between wind pressure and wind velocity:

$$P_z = 0.6 v_z^2$$

Where,

Pz = design wind pressure in N/m<sup>2</sup> at height z,

Vz = Design wind velocity in m/s at height z

### 3. Problem Statement

For G+20 storey building-

As per IS 875-1987(part-3)

Design wind speed(Vz)= Vbxk<sub>1</sub>k<sub>2</sub>k<sub>3</sub>

Where,

V<sub>b</sub>=47 m/s

k<sub>1</sub> and k<sub>3</sub>= 1

k<sub>2</sub>=1.18

∴ V<sub>z</sub>= 47x1x1.18x1=55.46 m/s

and

P<sub>z</sub>= 0.6xV<sub>z</sub><sup>2</sup>= 0.6x (55.46)<sup>2</sup>= 1845.48 N/m<sup>2</sup>

### 4. Modelling

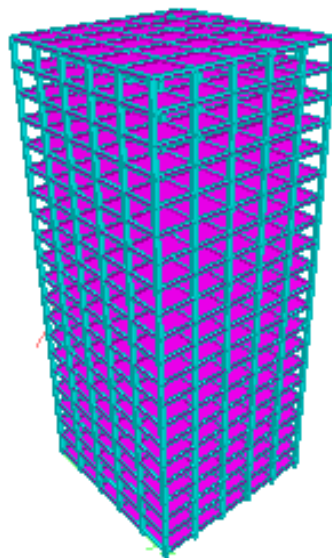

**Fig 3: G+20 Square Shape Building.**

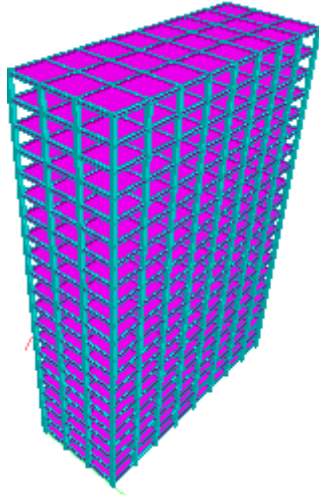

**Fig 4: G+20 Rectangular Shape Building.**

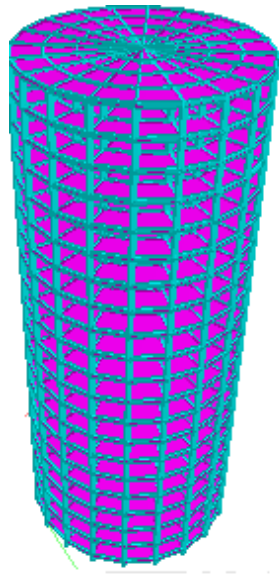

**Fig 5: G+20 Circular Shape Building.**

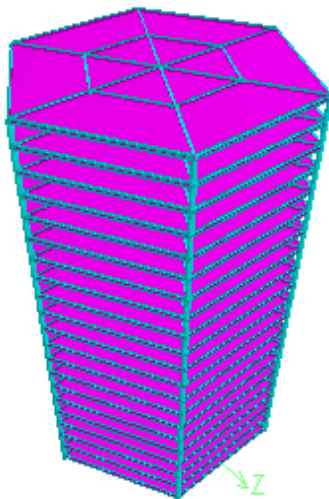

**Fig 6: G+20 Hexagonal Shape Building.**

## RESULTS AND DISCUSSION

From the study the results are discussed are as follows:

**Table 2 (a): Displacement of Buildings under loading conditions.**

Storey No.	Shape	Displacement X (mm)	Displacement Y (mm)	Displacement Z (mm)
G+20	Square	80.37	15.65	80.37
	Rectangular	44.74	14.65	149.11
	Circular	8.01	41.62	31.71
	Hexagonal	474.11	161.23	12023.3
G+40	Square	445.68	54.50	445.68
	Rectangular	224.79	52.23	979.72
	Circular	1545.43	76.56	1557.23
	Hexagonal	2331.39	309.56	4361.05

**Table 2 (b): Rotation of Buildings under loading conditions.**

Storey No.	Shape	Rot X (Rad/Sec)	Rot Y (Rad/Sec)	Rot Z (Rad/Sec)
G+20	Square	1.74422E-03	8.43044E-06	1.74422E-03
	Rectangular	3.04228E-03	-9.72353E-06	1.00395E-03
	Circular	5.02071E-03	6.07013E-04	5.06129E-03
	Hexagonal	-1.90116E-01	8.50733E-02	8.43729E-02
G+40	Square	4.24711E-03	1.28982E-05	4.24711E-03
	Rectangular	8.43485E-03	-1.82026E-05	2.36751E-03
	Circular	9.84922E-03	6.50197E-03	1.00103E-02
	Hexagonal	3.22642E-02	-8.86053E-02	2.59598E-02

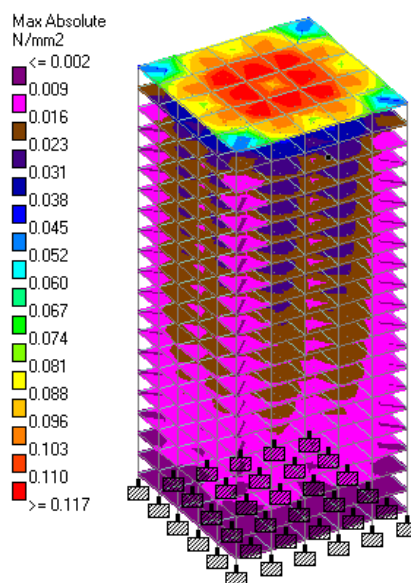

**Fig 7: Maximum Absolute stress of G+20 Square Shape Building.**

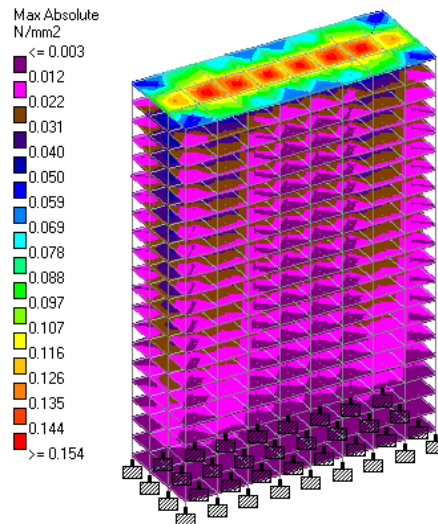

**Fig 8: Maximum Absolute stress of G+20 Rectangular Shape Building.**

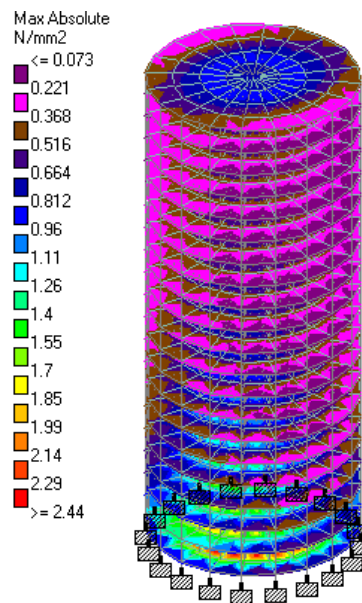

**Fig 9: Maximum Absolute stress of G+20 Circular Shape Building.**

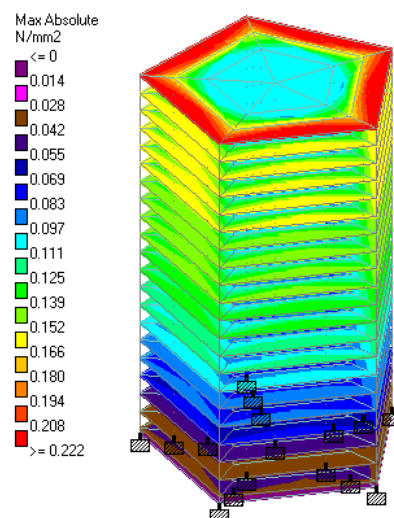

**Fig 10: Maximum Absolute stress of G+20 Hexagonal Shape Building.**

## CONCLUSION

- In this Paper wind response of high rise building is studied using design software STADD-pro v8i. Four parameters of shape Square, Rectangular, Circular, and Hexagonal are selected for zone II (Pune region basic wind speed 47 m/s).
- From results it is concluded as shape of the structure plays an important role in resisting wind loads. Circular shaped building performed the best followed by Rectangular shaped and square shaped building.
- For storey height G+20, G+40 it was observed that upto 20 storey height deflection along windward direction is less in Circular as compared to other shapes. However for G+40 storey the rectangular shape gives comparatively less deflection.
- Because of torsional eccentricity Rotation about X and Y direction is less in square shape and hexagonal shape which leads to better performance against torsional moment induced by wind. However less deflection in circular which leads to less stress in building.
- Also it is concluded as with the change in shape of building from Hexagonal, Square Rectangular and Circular the storey drifts and the lateral displacements of the building decreases respectively.

## FUTURE SCOPE

- Same Study should be performed by implementation of diagrid structure to check the deflection.
- Performance for steel building should be checked using same parameter.

## REFERENCES

1. Anupam Rajmani and Prof Priyabrata Guha “Analysis of wind and earthquake load for different shapes of high rise building” International Journal of Civil Engineering and Technology. 2015, 38-45
2. IS: 875(Part-I)-1987 Indian standard code of practice for design loads (other than earthquake) for buildings and structures, Part-1 Dead loads - Unit weights of building materials and stored materials.
3. IS: 875(Part-2)-1987 Indian standard code of practice for design loads (other than earthquake) for buildings and structures, Part-2 Impose Loads.
4. IS: 875(Part-3)-1987 Indian standard code of practice for design loads (other than earthquake) for buildings and structures, Part-3 Wind Loads.

5. J. A. Amin and A. K. Ahuja “Characteristics of wind forces and responses of rectangular tall buildings” *International Journal of Advanced Structural Engineering*, 2014; 1-14.
6. Ning Lin, Chris Letchford, Yukio Tamura, Bo Liang and Osamu Nakamura “Characteristics of wind forces acting on tall buildings” *Journal of Wind Engineering and Industrial Aerodynamics*, 2005; 217–242.
7. Ritu Raj and Ashok Kumar Ahuja “Wind Loads on Cross Shape Tall Buildings” *Journal of Academia and Industrial Research*, 2013; 111-113.