

LIGHTING CONTROL SYSTEM AND MONITORING OF ELECTRICAL CURRENT, POWER AND ENERGY CONSUMPTION WITH REAL-TIME ALERTING THROUGH IOT

J. L. Sanchez-Cuevas^{1*}, J.I. Hernandez-Vega², P.D. Manrique-Peña¹, R.H. Estrada-Ruiz¹, A. Flores-Valdes¹, M. Sanchez-Lopez¹, H.J. Guardiola¹

¹National Institute of Technology of Mexico/Salttillo Institute of Technology, Department of Computer Systems Engineering, Av. Venustiano Carranza 2400, Col. Tecnologico, C.P 25280, Saltillo, Coahuila, Mexico.

²National Institute of Technology of Mexico/Nuevo Leon Institute of Technology, Department of Graduate Studies and Research, Av. Eloy Cavazos 2001, Col. Tolteca, C.P 67170, Guadalupe, Nuevo Leon, Mexico.

Article Received on 20/09/2019

Article Revised on 10/10/2019

Article Accepted on 30/10/2019

*Corresponding Author

J. L. Sanchez-Cuevas

National Institute of Technology of Mexico/
Salttillo Institute of Technology, Department of Computer Systems Engineering, Av. Venustiano Carranza 2400, Col. Tecnologico, C.P 25280, Saltillo, Coahuila, Mexico.

ABSTARCT

It was developed an Internet of things (IoT) application with Ubidots intuitive IoT development platform for controlling lights through any device connected to the Internet, also, a remote monitoring of electrical current, power, electrical energy and the accumulated cost of energy consumed in a building, school, company and/or any other corporate that requires it. This is because according to the Department of Energy in Mexico, the 28% of the emissions of the carbon dioxide (CO₂) comes from the production of electricity. The results show that it is possible to control the on / off switching of luminaires and the monitoring of electrical variables through IoT to save electricity.

KEYWORDS: Internet of things, application, electrical current, power, electrical energy.

1. INTRODUCTION

Total emissions of Greenhouse Gas (GHG) in Mexico are around 709 million tons, of which

493 million tons correspond to carbon dioxide (CO₂). In emissions from stationary sources such as electricity generation, the federal entity that reports highest emissions of CO₂ is Coahuila, Mexico, and this is explained because it is the home of two electric power plants by coal and steel. In 2010, the total emission of CO₂ by energy consumption was 407.3 Mega tons, highlighting the stationary sources such as electricity generation which contributed 28%, the industry of energy (extraction, refining, etc.) with 10%, and the rest from industry 23%, and non-stationary sources like transport 39%.^[1]

Considering that the generation of electricity contributes significantly to the generation of greenhouse gases, one of the main objectives of the office of the future is to increase the efficiency of the buildings out of respect to the environment, but, above all, because it involves a saving on bills at end of month. Thanks to the internet of things, companies can save energy by controlling the environment in the office. This is possible by intelligent control of lights and heating system and connecting it to the internet so that it can share information. Thus costs are reduced and energy makes the most.^[2]

With the Internet of things all kind of sensors and electrical appliances can be connected to the Internet.^[3] This paper intends to have an on/off control of lights in a building, school or any other corporate which so desired also with the monitoring of the electrical current, power, electrical energy, and the cost of energy consumption in real time through the IoT over an application developed on the Ubidots platform.

2. MATERIALS AND METHODS

2.1 *Materials*

For the development of the lighting control system and monitoring of electrical current, power, and electrical energy was necessary to have the following materials: electrical current sensor, motion sensor, ambient light sensor, IoT "Particle Photon" device, relays or actuators, and in the field of software it was necessary to have the "Particle" development platform, and the visualization platform which is Ubidots.

2.2 *Non-Invasive Electrical Current Sensor*

This non-invasive current sensor (also known as a "split core current transformer") can be clamped around the supply line of an electrical load to tell you how much current is passing through it. It does this by acting as an inductor and responding to the magnetic field around a current-carrying conductor. By reading the amount of current being produced by the coil, you

can calculate how much current is passing through the conductor [4]. Figure 1 shows the type of sensor used.



Figure 1: Non-Invasive electrical current sensor.

Such sensors are sensors that work like transformers, electrical current flowing through the wire that we want to measure acts as the primary winding (1 loop) and internally has a secondary winding of 2000 spires., i.e. a relation of 1:2000 which It means for example that gives us a measure of 1mA output by each 2A circulating in the power line to be measured. With this reading the amount of current produced by the coil, you can calculate the amount of current flowing through the conductor.

2.3 PIR Motion Sensor

Passive infrared (PIR) sensors are motion-detecting devices used in security. Basically they use the variation of the infrared radiation from the environment that covers. These capture the presence by detecting the difference between the heat emitted by the human body and the space around.^[5] Figure 2 shows the type of sensor used.



Figure 2: PIR Motion Sensor.

The PIR sensor is a digital sensor that makes change of state the pin associated with the signal in function if it detects any presence or not, this pin provides a level of 5 or 3.3V voltage (when detects presence) and 0V (when it does not detect presence).

2.4 Ambient Light Sensor

Light sensors have all sorts of practical uses in the modern era, most notably in devices with auto-brightness for their screens and in digital cameras to adjust exposure. Light Sensor will detect the brightness of its surroundings. Sensor acts like a transistor - the greater the incoming light, the higher the analog voltage on the signal pin. The analog voltage can vary

from 0 to 3.3V depending on the amount of ambient light.^[4] Figure 3 shows the type of sensor used.



Figure 3: Ambient Light Sensor.

2.5 Particle Photon

Particle's IoT (Internet of Things) hardware development kit, the Photon, provides everything you need to build a connected project. Particle has combined a powerful 120Mhz ARM Cortex M3 micro-controller with a Broadcom Wi-Fi chip in a tiny thumbnail-sized module called the PØ (P-Zero).

This device provides everything you need to connect sensors and actuators to the cloud through Wi-Fi. This device is equipped with digital inputs/outputs, analog inputs through its analog-to-digital converter (ADC), also features PWM outputs and its operating voltage for inputs and outputs of any type is 3.3V.^[6] Figure 4 shows the device used for IoT applications.

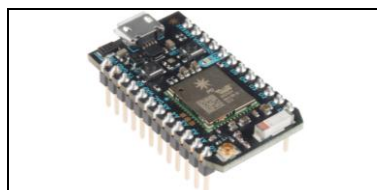

Figure 4: Particle Photon.

2.6 Relay

A relay is an electrically operated switch. Relays are used where it is necessary to control a circuit by a separate low-power signal, or where several circuits must be controlled by one signal. This relay uses an electromagnet to mechanically operate a switch. In this case the relay will be commissioned to turn on or off the lights depending of the signal of the IoT device. Figure 5 shows the type of relay used.

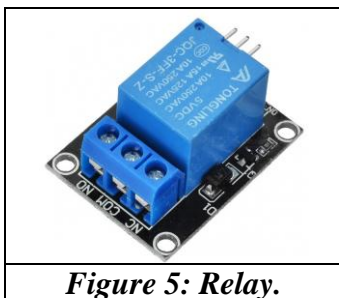

Figure 5: Relay.

2.7 Particle Cloud

Every Particle photon device connects to the Particle Cloud – a secure, scalable, and reliable gateway between the devices and the web. Programming the device is over-the-air through the easy-to-use Web IDE, in which the programming code is written for the readings of the sensors, to activate relays and to send information to other platforms for viewing data as Ubidots. The programming language used in the Web IDE is C/C++.

2.8 Ubidots Platform

Ubidots is an Internet of Things (IoT) data analytics and visualization platform, it turns real-time sensor data into information that matters for business-decisions. Ubidots exists as an easy and affordable means to integrate the power of the IoT into your business or research.^[7]

Ubidots platform is a platform of IoT to mainly display information from sensors connected to the cloud and to operate relays via buttons, predefined by the platform. Ubidots gives users the tools to remotely monitor information from sensors and actuators operate through different types of graphics and animations.

2.9 Block Diagram: System Integration

In Figure 6 shows a block diagram that illustrates the integration of the developed system. In the first instance the electrical current sensor, motion sensor and ambient light sensor are physically connected to the device of IoT, which is the Particle Photon, this device is connected to the Particle Cloud, and in this cloud the device is programmed to obtain the information from sensors, once the information from sensors, this information is sent via webhooks or "HTTP callbacks from user" to the visualization platform (Ubidots) which can be viewed through their own mobile app or through a web page from any device such as a laptop or computer. Well, now for the power of luminaries, from the mobile app or from a PC or laptop you press a virtual button on the Ubidots platform and this information is sent to the Particle cloud platform which informs the Particle Photon device which enable / disable relay or actuator that is what makes you turn on/off the luminaires.

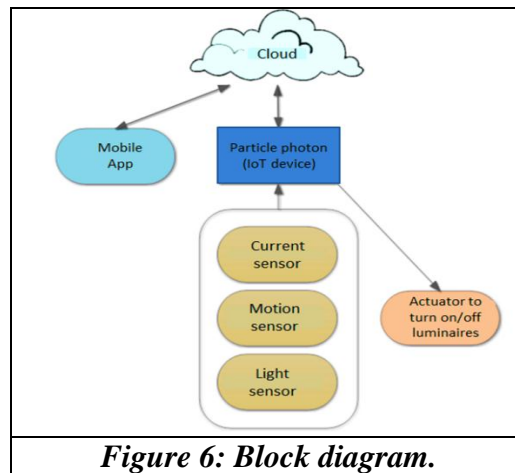

2.10 Connections

In Figure 7, shows the integration of the system, about sensors, actuators which are connected to the Particle Photon device. Electrical current sensor was connected to the analog input "A0" of the Particle Photon and depending on the amount of voltage measured gets the value of the electrical current flowing through the power line in a building or corporate. The motion sensor was connected to the digital input "D0" of the Particle Photon and when a movement is detected, the sensor sends a pulse of voltage from 3.3V to this entry, more forward operation algorithm will be displayed. The light sensor was connected to the analogue input "A4" of the Particle Photon and depending of the amount of light, the sensor sends an analog voltage to this input. The analog voltage can vary from 0 to 3.3V depending on the amount of ambient light and where we can define the range of voltage for "day" and the range of voltage for "night". The relay was connected to the digital output of the Particle Photon "D4" and this is responsible for serving as a switch for on/off switching of luminaires. Digital voltage outputs from Particle Photon can be 0V (OFF) or 3.3V (ON).

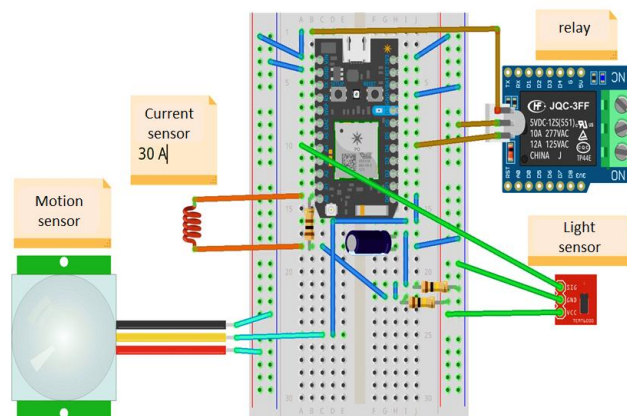

Figure 7: Connections.

2.11 Algorithm

Figure 8, shows the flowchart of functioning which will be explained below.

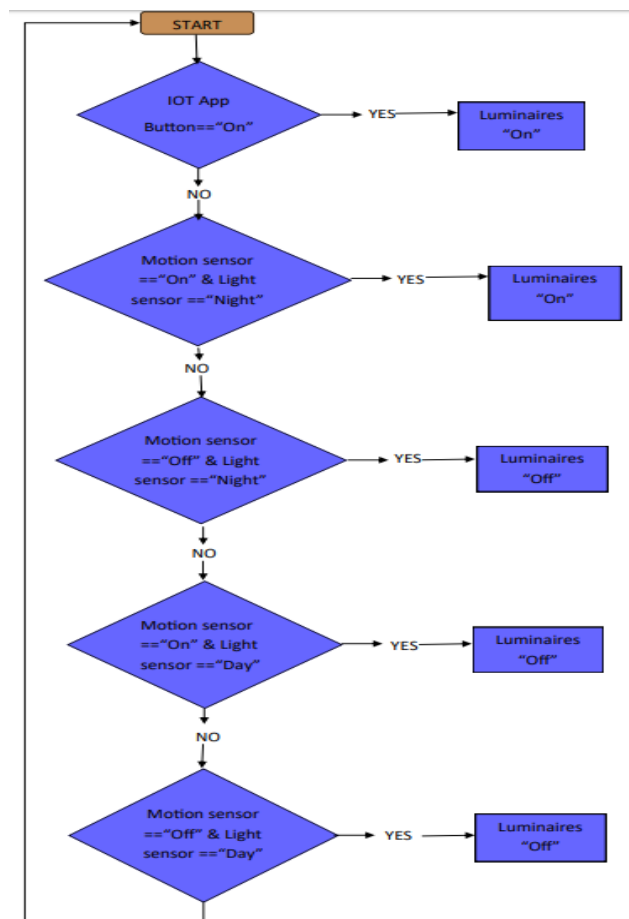

Figure 8: Flowchart.

Algorithm is as follows

- a) Start
- b) If I press from the mobile application the virtual button "on", it will turn on the luminaire, if not, it goes to subsection "c"
- c) If there is movement inside a room of a building and the light sensor indicates that there is not enough ambient lighting, the luminaire will turn on, otherwise it goes to subsection "d".
- d) If there is no movement inside a room of a building and the light sensor indicates that there is not enough ambient lighting, the luminaire must remain off, if not, go to subsection "e".
- e) If there is movement inside a room of a building and the light sensor indicates that there is sufficient ambient lighting, the luminaire must remain off, otherwise it goes to subsection "f".

- f) If there is no movement inside a room of a building and the light sensor indicates that there is enough ambient lighting, the luminaire must remain off, otherwise goes to subsection “a”

If you are in any of the above conditions, the only one who has the master interrupt control is the virtual button to force start-up or shutdown of the luminaires.

In Figure 9 is shown the C++ programming code used by the Particle board platform to set the algorithm mentioned above. It uses the "Ubidots.h" and in consequence of the "Ubidots" class the object "ubidots" is generated. It includes the constant "TOKEN" which is the process of authentication for access for sending data to the Ubidots platform. The 'value' variable is used to receive the value from the virtual button for on/off switching of luminaires from anywhere in the world, the variable "s_mov" is used to receive the information from the motion sensor and the variable "s_luz" is used for receiving information from the light sensor, the variable "dark" is the variable to set the decimal meaning of low light. The function "void setup" defines the digital input "D0" which is where the motion sensor is connected, and in function "void loop" executes the above mentioned main algorithm. With the object and the function "ubidots.add" we add the present value of the electrical current and the measured power and "ubidots.sendAll" send all the values of these variables to the Ubidots platform in a span of every 5 seconds.

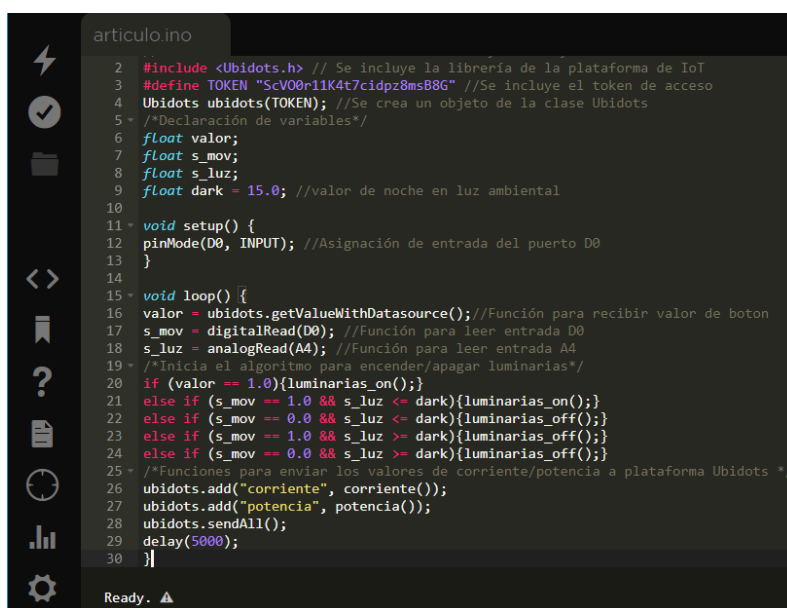

```
articulo.ino
2 #include <Ubidots.h> // Se incluye la librería de la plataforma de IoT
3 #define TOKEN "ScV00r11K4t7cidpz8msB8G" //Se incluye el token de acceso
4 Ubidots ubidots(TOKEN); //Se crea un objeto de la clase Ubidots
5 /*Declaración de variables*/
6 float valor;
7 float s_mov;
8 float s_luz;
9 float dark = 15.0; //valor de noche en luz ambiental
10
11 void setup() {
12   pinMode(D0, INPUT); //Asignación de entrada del puerto D0
13 }
14
15 void loop() {
16   valor = ubidots.getValueWithDatasource(); //Función para recibir valor de boton
17   s_mov = digitalRead(D0); //Función para leer entrada D0
18   s_luz = analogRead(A4); //Función para leer entrada A4
19   /*Inicia el algoritmo para encender/apagar luminarias*/
20   if (valor == 1.0){luminarias_on();}
21   else if (s_mov == 1.0 && s_luz <= dark){luminarias_on();}
22   else if (s_mov == 0.0 && s_luz <= dark){luminarias_off();}
23   else if (s_mov == 1.0 && s_luz >= dark){luminarias_off();}
24   else if (s_mov == 0.0 && s_luz >= dark){luminarias_off();}
25   /*Funciones para enviar los valores de corriente/potencia a plataforma Ubidots */
26   ubidots.add("corriente", corriente());
27   ubidots.add("potencia", potencia());
28   ubidots.sendAll();
29   delay(5000);
30 }
```

Figure 9: Programming Code.

3. RESULTS AND DISCUSSION

3.1 Virtual button

The prototype used for this system consists of 3 light bulbs, where each light bulb represents a room of a building. In Figure 10, shows the screen of the mobile app of the virtual button to turn on or turn off lights according to the room that is selected.



Figure 10: Virtual button.

3.2 Monitoring of electrical current and power in real-time

In the Figure 11, shows the monitoring of electrical current and power when 1 light bulb is turned on, here we see a current of 0.20A and a power of 25.92W this because the light bulb is of 25W. All this monitoring is in real-time.

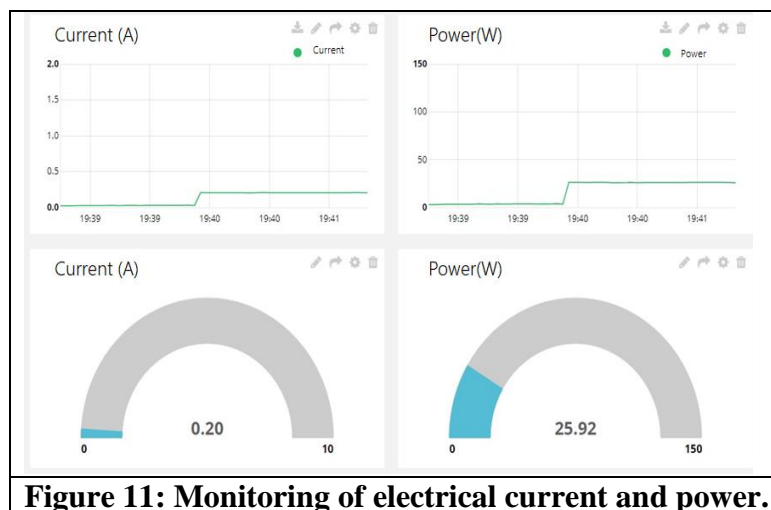

Figure 11: Monitoring of electrical current and power.

In Figure 12, shows the monitoring of electrical current and power when 3 lights bulbs are turned on, here we see a current of 0.60A and a power of approximately 75W, this because every light bulb is of 25W.

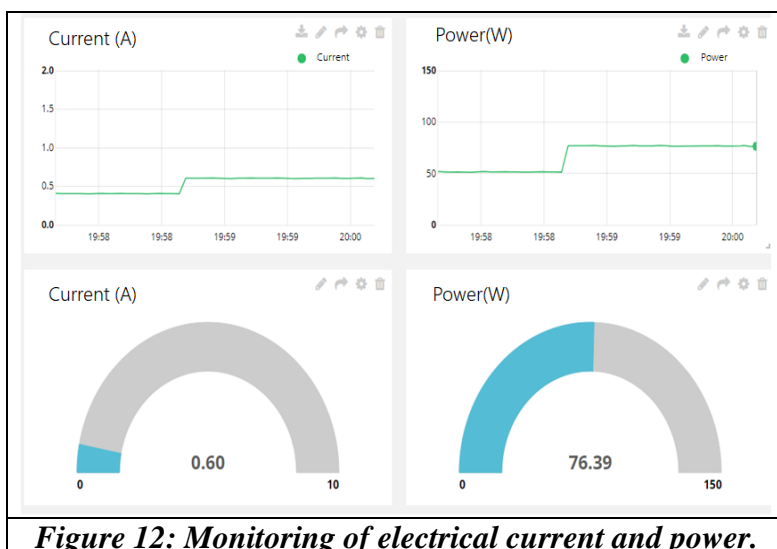

Figure 12: Monitoring of electrical current and power.

3.3 Monitoring of electrical energy and cost amount in real-time

In Figure 13, shows that it is possible the monitoring of electric energy in kW/hr. It is worth mentioning that the energy consumed by any equipment or appliance is calculated by multiplying the power of the appliance by operating time and is measured in watts per hour (Wh). It also shows the accumulated cost of energy consumed and this is possible to know the estimated cost of KW/hr., in this case the cost is in Mexican Pesos (\$MXP), but could be in any currency.

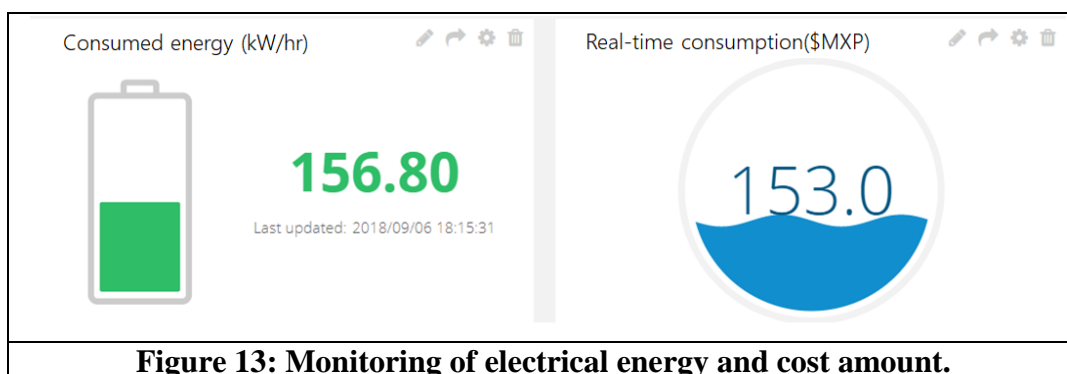

Figure 13: Monitoring of electrical energy and cost amount.

3.4 Alert by SMS

One of the important aspects of the Ubidots platform is that it allows you to create alerts when a certain measured limit is exceeded. In this case, it was assigned that when the power exceeds 70W, it will send us an SMS. That is, when the third light is switched on, the power will exceed 70W. In Figure 14, the result is shown.

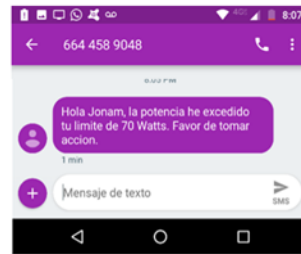

Figure 14: Alert by SMS in real-time.

Real-time alerts are very important because we can take actions to, for example, force the shutdown of certain luminaires if required.

4. CONCLUSIONS

It was developed an application of Internet of things (IoT) through the platform of development Ubidots for the control “on/off” of luminaries from any device connected to the Internet, likewise the remote monitoring of the consumption of electrical current, the power, electrical energy and the cumulative cost of energy consumed in a building, school, company, or any other corporate which so requires. Real-time alerts were also added to notify us via SMS if we have exceeded a certain power limit, and with this take appropriate actions.

5. REFERENCES

1. DGTIC, w. CO2. Retrieved from <http://co2.energia.gob.mx/>, 2018.
2. Nadal, M. Siete formas en que el internet de las cosas cambia nuestro trabajo. Retrieved from https://retina.elpais.com/retina/2018/01/22/talento/1516639374_582456.Html, 2018.
3. Monk, S. Make: Getting started with the photon (1st ed., p. 95). Maker Media, Inc., 2015.
4. SparkFun Electronics. Retrieved from <https://www.sparkfun.com>, 2018.
5. Villegas, J. Qué es un detector de movimiento pasivo o PIR y cómo funcionan los sensores de movimiento. Retrieved from <https://www.tecnoseguro.com/faqs/alarma/que-es-un-detector-de-movimiento-pasivo-o-pir>, 2018.
6. Particle - Welcome to real IoT. Retrieved from <https://www.particle.io/>, 2018.
7. Iot platform | Internet of Things | Ubidots. Retrieved from <https://ubidots.com/>, 2018.