

## REVIEW ON DESIGN CODES AND PROVISIONS RELATED TO PROGRESSIVE COLLAPSE

Sanjeev Bhatta<sup>a\*</sup>, Yang Jian<sup>a,b</sup> and Qing-Feng Liu<sup>a</sup>

<sup>a</sup>School of Naval Architecture, Ocean and Civil Engineering, Shanghai Jiao Tong University, Shanghai

<sup>b</sup>School of Civil Engineering, University of Birmingham, UK.

Article Received on 21/04/2020

Article Revised on 11/05/2020

Article Accepted on 01/06/2020

### \*Corresponding Author

Sanjeev Bhatta

School of Naval Architecture, Ocean and Civil Engineering, Shanghai Jiao Tong University, Shanghai.

### ABSTRACT

Well documented timeline with major progressive collapse events and the evolution on development of design codes or standard are presented. In addition, the process of progressive collapse along with the prevention strategies and some prevailing design methods of progressive collapse of building structures are studied under threat dependent and threat independent design methods. For aiming to

minimize the risk of causing progressive collapse, some structural traits need to consider in the design of building structures are also presented.

**KEYWORDS:** Progressive Collapse, Design Codes, Design Methods.

### 1. INTRODUCTION

The fundamental characteristics of progressive collapse is that the failure at the final state is much larger than the failure that occurred initially by any abnormal events (Ellingwood et al., 2007). For this reason, beams, columns and frame connections should be designed in order to provide an alternative path for the redistribution of large loads. Many attempts have been seen to address the progressive collapse issue in various regulatory guidelines (American Society of Civil Engineers (ASCE), 2010; GSA, 2003; UFC, 2003), codes or standards (ACI Committee 318, 2011; American Society of Civil Engineers (ASCE), 2010). Consequently, to mitigate the progression of progressive collapse in designing new or retrofitting existing buildings has become crucial issue for structural engineers. Most researchers approach it by

paying attention to ductility, continuity, integrity and energy absorption capability that structures should acquire.

During the last decade, the progressive collapse resistance of structures has been investigated in-depth through various experimental and numerical analysis techniques. Remarkable efforts have been made towards understanding the failure-resistant mechanisms (Li et al., 2016; Qian et al., 2014), collapse patterns (Sagiroglu & Sasani, 2014), time-dependent effects (Li et al., 2014a, 2014b; Tsai & Lin, 2008) and developing various failure-resistant design methods (Izzuddin et al., 2008; Li et al., 2011; Xu & Ellingwood, 2011) and codes. The current design codes (ASCE, 2010; BS8110, 1997; EN 1991-1-7, 2006) and specific guidelines (Department of Defense (DoD), Unified facilities criteria (UFC), 2010; General Service Administration (GSA), 2013; GSA, 2003) developed strengthening techniques considering exterior and internal, middle and corner loss of vertical load bearing elements. ASCE (ASCE, 2010) proposes three alternative methods such as the alternative load path, the specific local resistance direct methods, and indirect design method to prevent progressive collapse. Meanwhile, the process of progressive collapse of building structures can be analyzed using different degree of idealization, from the simple linear static procedure to the complex nonlinear dynamic analysis. Marjanishvili and Agnew (Marjanishvili & Agnew, 2006) discussed pros and cons of the four methods, namely; linear static, nonlinear static, linear dynamic, and nonlinear dynamic methods, in conducting the progressive collapse analysis.

## **2. Collapse Events and Development of Design Provision: Timeline**

Due to increased terrorism buildings are designed to resist progressive collapse. Figure 11 shows the timeline of well-known progressive collapse events on upper part, occurred since 1966 to till date along with the developments of various design codes and standards on the lower part. The UK standards and the National Building Code (NBC) of Canada began to explicitly implement for progressive collapse design after the partial collapse of Ronan Point Apartment building in London, UK in 1968. Due to little interest of structural engineering communities, the development of codes was passive between 1975 and 1995. There has been fierce interest after the disproportionate collapse of Alfred P. Murrah Federal building (1995) and the total collapse of the World Trade Center Towers (2001) and a number of design codes and standards (DoD and GSA) were developed to reduce the likelihood of occurring progressive collapse in structures.

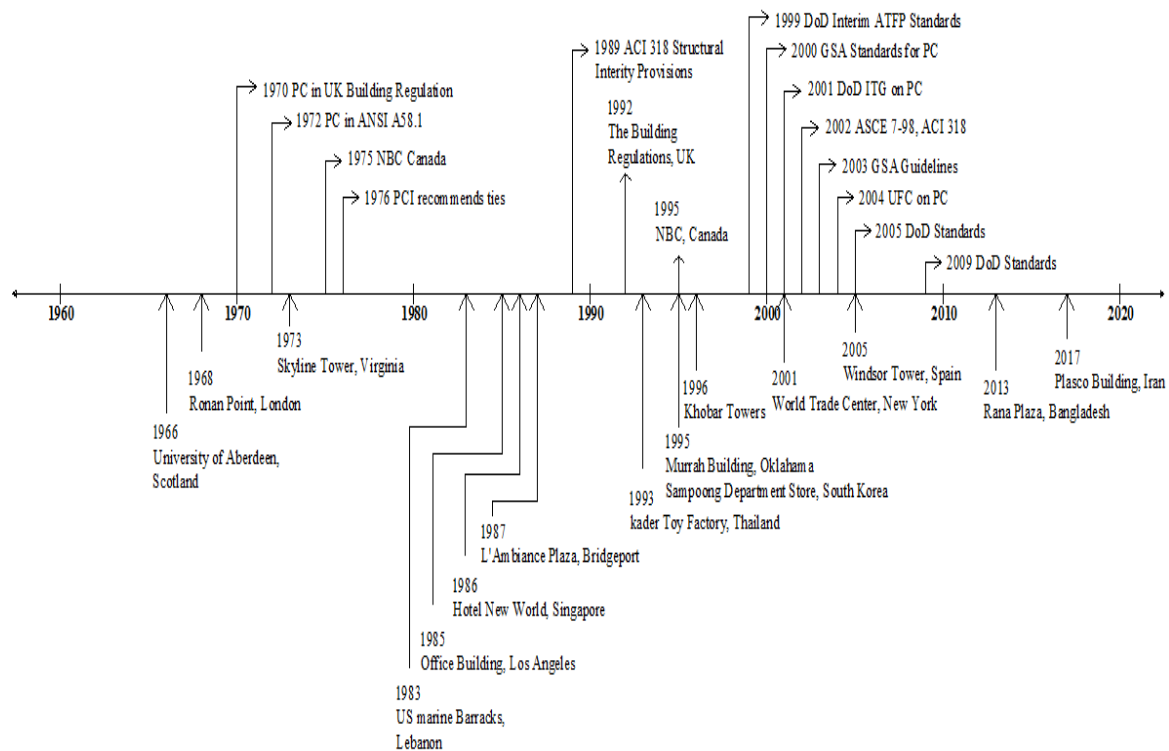

**Figure 1: Time line of progressive collapse events and development of design provision.**

### 3. Existing Design Codes and Guidelines

#### 3.1 British Standards

The British code addressed the progressive collapse issue in the building standards for the first time after the partial collapse of Ronan apartment in 1968. British standards require considering the effects of accidents for design and construction of five and more than five stories structures. The British code proposed three design methods to be incorporated in design to prevent the collapse of structure; (i) Tying design: The provision of continuous horizontal and vertical ties in a structure helps to improve the structural integrity and redundancy rate. These ties are provided to provide alternate load paths when a structural element is lost. The tensile force considered in designing the internal ties is estimated at 50% of the factored floor loads but not lower than 75 KN (Vlassis & A.G., 2007). (ii) Bridging design: The British code requires incorporating bridging methods when the tying of the buildings cannot be made. It requires the horizontal member provides catenary action and do not completely fails when a vertical structural member is lost. The performance satisfactory is achieved only if the collapse region is limited to lesser than 15% of the story area or 70 m<sup>2</sup> (Shams-AL, 2012) (iii) Key element design: The element which can cause wide range of damage in a structure after removing it should be design as a key element (Vlassis & A.G.,

2007). It is mentioned that the key element should be able to sustain extra  $34\text{KN/m}^2$  of uniformly distributed load at each directions (Shams-AL, 2012).

### 3.2 Canadian Code

After the partial collapse of Ronan Point Apartment in 1968, National Building Code of Canada (National Research Council of Canada, 1975) try to address the collapse through structural integrity in 1975 as shown in progressive collapse timeline history in Figure 11. It also summarized some preventive measures such as providing ductility in the connections, design to sustain the load if an individual structural element is removed by an abnormal event, and establishing alternate load paths. In 1977, modification was made to address the progressive collapse issue that structures shall be designed to minimize the occurrence of local failure and prevent it from spreading to other structural members. The 1980 edition which took out the “Structural Integrity” clause from section 4.1.1.8 and added “Minimum Safety, Performance and Integrity” on section 4.1.1.3(1), is quiet short and contains no design details as compared with the 1975 and 1977 editions. All the later editions including the present edition prepared in 1995 have not addressed the progressive collapse issue directly in any other sections expect section 4, which covers for structural integrity and defined structural integrity as “the ability of the structure to absorb local failure without widespread collapse”.

### 3.3 Euro code

EN 1990:2002 (European Standard, 2002) has given the basic for structural design which states that the structures shall be designed and executed with suitable degree of structural robustness so that it will not be affected by any abnormal events such as explosion, impact and the consequences of human errors. Two strategies are given in EN 1991-1-7:2006 to prevent structures from accidental events.

The first strategy is established on identified extreme events such as internal explosions, impact, etc. and contains (i) Structures shall be designed to provide sufficient robustness; (ii) Providing protective measures to reduce the intensity of action; (iii) Designing structures to withstand such action. The second strategy is established to limit the spreading of local failure by adopting the provisions as, (i) Provide mechanism for alternate load path; (ii) Design of key element; (iii) Provide integrity and ductility.

### **3.4 National Institute of standards and Technology (NIST)**

NIST published an article entitled “Best Practices for Reducing the Potential for Progressive Collapse in Buildings” (Ellingwood et al., 2007) in 2007 with the objectives to have extensive review on the progressive collapse mitigating methods and current design codes, such as, DoD and GSA, to resist progressive collapse. Even though this document is intended to inform investors and practicing engineers with current suitable practices to avoid the occurrence of progressive collapse of structures caused by any abnormal events, nevertheless it recommends general structural integrity requirements (Menchel, 2009).

### **3.5 ASCE 7-02 “Minimum Design Loads for Buildings and Other Structures”**

The standard developed by American National Standards Institute Standard ANSI A58.1 in 1982 was later handled by ASCE and was called “Minimum Design Loads for Buildings and Other Structures”(ASCE 7-02, 2002.). Several recommendations are made in section 1.4 of ASCE 2002 to enhance the general integrity of the structure in progressive collapse issues so that the structures sustain the local failure and failure at the final stage should not be disproportionately larger than the initial stage (Dusenberry & Juneja, 1998.). ASCE 2002 does not deal with extreme loading case or specific threat; however it addresses design approaches i.e. direct and indirect approaches. Direct design methods utilize either Specific Local Resistance Method or the Alternate Path Method to resist progressive collapse, whereas, indirect design methods mitigate progressive collapse by providing minimum level of continuity, strength, redundancy and ductility. The general structural integrity section remained unchanged since ASCE handled this standard as ASCE 7 to the most recent revision version. Some specific suggestions made by the ASCE 2002 in its current revision as non-mandatory comments to enhance the general structural integrity includes good plan layout, integrated system of ties, returns on walls, changing directions of span of floor slab, load bearing interior partitions wall, redundant structural system, beam action of wall, ductile detailing, and providing additional reinforcement and compartmentalized construction combined with special moment resisting frame.

### **3.6 ACI 318-05 “Building Code Requirements for Structural Concrete”**

The ACI code applies indirect design approaches proposed by ASCE to address the progressive collapse issues. It requires sufficient continuity, ductility and redundancy to enhance the overall stability and integrity of the structures (ACI 318, 2011). Section 7.13 of this code made the statement on structural integrity as “Experience has shown that the overall

integrity of a structure can be substantially enhanced by minor changes in detailing of reinforcement. It is the intent of this section of the code to improve the redundancy and ductility in structures so that in the event of damage to a major supporting element or an abnormal loading event, the resulting damage may be confined to a relatively small area and the structure will have a better chance to maintain overall stability” (ACI 318, 2011). The requirements for pre-cast concrete are described in section 16. However, there is no assurance that adopting these recommendations in design effectively avoids the disproportionate collapse because the primary concepts are not clear (Brown, 2010).

### **3.7 General Service Administration (GSA) 2003**

In June 2003, the US General Service Administration released revised design guidelines entitled “Progressive Collapse Analysis and Design Guidelines for New Federal Office Buildings and Major Modernization Projects” (GSA, 2003) developed in 2000, with an intention to restrict the spread of damage to a larger extent after a local damaged has occurred. Moreover, the requirements specified in GSA (2003) were developed to meet the provisions of the Security Criteria on the progressive collapse developed by the Interagency Security Committee (ISC). This design guideline implements alternate path method and linear elastic and static approach analysis method to accomplish progressive collapse analysis. Linear procedures are carried out for progressive collapse analysis of buildings with 10 or less stories, whereas, nonlinear procedures are used for buildings with more than 10 stories. Section 4 of this guideline describes the design and analysis procedures for resistance to progressive collapse into two subheadings; (a) new construction, and (b) existing construction.

GSA suggested performing the analysis of typical structures considering the location of column removal. For the analysis of exterior column removal case in frame or flat plate structures, the analysis is performed considering the loss of exterior load carrying element for ground floor at or near the middle of short side, middle of long side, or at the corner of the structure, Figure 13(a). Likewise, for interior column removal case, the analysis is performed considering the loss of one load bearing element joining floors to underground parking and/or uncontrolled public ground floor area to the first story, Figure 13(b).

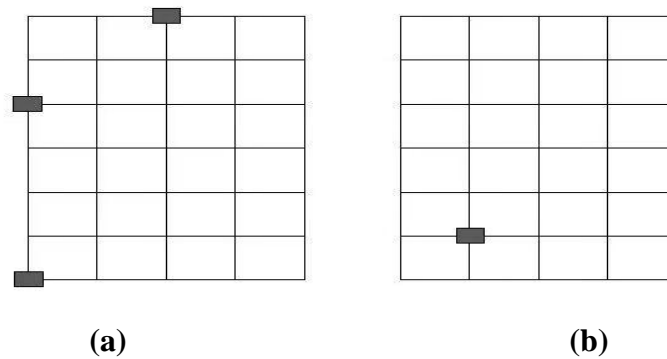

**Figure 1: Location of removed columns for (a) exterior considerations (b) interior considerations(GSA, 2003).**

For the analysis external column removal case in case of shear/load bearing wall structures, the analysis is performed considering the instantaneous removal of lesser of one structural bay or 30 linear foot from the exterior wall section of the first floor located at or near the middle of short side or middle of long side. The corner wall removal analysis is carried out removing the lesser of whole load bearing wall along the perimeter at the corner bay or 30 linear feet (15 feet in each direction) as displayed in Figure 14(a). Likewise, for interior column removal case, the analysis is carried out considering the instantaneous removal of lesser of one structural bay or 30 linear feet from interior wall section at the floor level of the uncontrolled ground and/or underground parking area as shown if Figure 14(b).

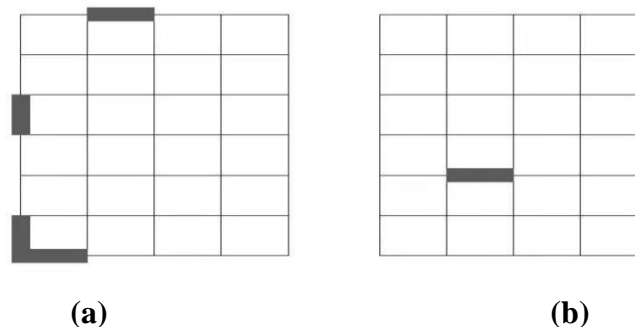

**Figure 2: Location of removed load bearing wall for (a) exterior considerations (b) interior considerations(GSA, 2003).**

The following equations (3) and (4) are taken into considerations for linear or nonlinear static and linear and nonlinear dynamic analysis of structures respectively, where dynamic amplitude factor of 2.0 is considered for dynamic analysis.

$$\text{Load} = (\text{DL} + 0.25 \text{ LL}) \quad (3)$$

$$\text{Load} = 2 (\text{DL} + 0.25 \text{ LL}) \quad (4)$$

Where DL is the dead load and LL is the live load.

GSA(GSA, 2003) has introduced buildings having regular and irregular configuration as ‘typical’ and ‘atypical’ buildings respectively. The progressive collapse potential is determined by comparing their demanded capacity to strength capacity and their ratio is defined as Demand Capacity Ratio (DCR) in design guidelines of GSA.

DCR $\leq$ 2 for typical structural configuration

DCR $\leq$ 1.5 for atypical structural configuration

### **3.8 General Service Administration (GSA) 2013**

The 2003 GSA guidelines were modified and released in October 2013 with the purpose for keeping consistency with The Interagency security Committee (ISC 2013) standards. Also, the 2013 GSA guidelines target to decrease the possibility of progressive collapse by bridging over the lost vertical structural components, limit on widespread of local damage, and provide redundancy. Furthermore, it addresses the right to save lives and avoid injuries as well. GSA 2003 recommends the use of dynamic amplification factor of 2 whereas; GSA 2013 replaced this by a factor  $\Omega$  that depends on structure type, material, and analysis procedure. The implementation of progressive collapse depends on number of stories and Facility Security Levels (FSL) in accordance with ISC. For FSL I and II, it is not required to adopt progressive collapse design, whereas, For FSL III and IV, alternate load path and redundancy and for FSL V, only alternate path methods should necessarily be adopted for progressive collapse design.

### **3.1 Department of Defense (DoD)**

The United State Department of Defense in June 2005 released “Design of Structures to resist progressive collapse” (UFC, 2005) for the construction of military buildings with three or more stories and major renovations. The design and analysis method is based on the level of protection (LOP) and the occupancy category (OC). This standard follows direct design and indirect design methods showed in ASCE 7-02. Both direct and indirect design procedures are applied for the design of medium and high levels of protection, whereas, indirect design methods are used for the design of very low and low levels of protection. It reflects the details description of progressive collapse design and evaluation of newly develop and existing



structures respectively built by masonry, wood, reinforced concrete, steel structures and cold-formed steel structures.

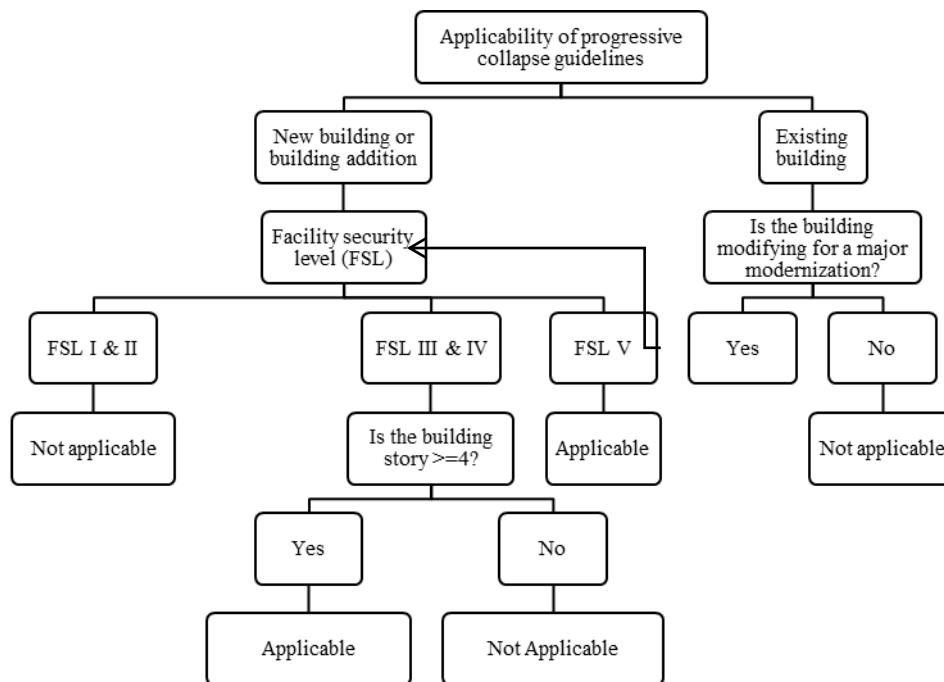

**Figure 3: Applicability flow chart for progressive collapse analysis adopted from GSA 2013(GSA, 2013).**

Structures are required to perform analysis at different locations, exterior or interior based on the effect of initiating events. Unlike GSA (2003), DoD (2005) require every planimetric position with removed component at every story should be analyzed with Alternate Path Method. The Alternate Path Method has three analytical methods: Linear Static, Nonlinear Static and Nonlinear Dynamic analysis in DoD (2005). In July 2009, U.S. Department of Defense made significant change of DoD (2005) and issued “Design of Structures to Resist Progressive Collapse” (DoD, 2009). In DoD (2009), only the location about the removal of vertical members is same as DoD (2005), the rest were changed. The DoD (2009) is based on the level of occupancy and building function.

#### 4. The Design Approaches To Prevent Progressive Collapse

The probability of occurrence of disproportionate collapse as a result of an abnormal event,  $P[C]$ , as expressed in equation (a), is explained as the product of probabilities of occurrence of abnormal event  $P[E]$ , conditional probability of initial damage caused by abnormal event  $P[D|E]$ , and conditional probability of a disproportionate spreading of failure  $P[C|D]$  (Ellingwood *et al.*, 2007). The progressive collapse of building structures occurs in four

stages as shown in Figure 15; (i) an abnormal load acts on a structure; (ii) initiation of local damage on structural members; (iii) failure of adjoining members in the remaining structure due to the load redistribution; (iv) the progressive collapse of the structure is initiated. Progressive collapse of building structure can be successfully prevented if any stage on the process of progressive collapse is controlled. The corresponding engineering strategies are summarized in Figure 15 to avoid the occurrence of progressive collapse of structures. The probability of occurrence of a disproportionate collapse  $P[C]$  can be limited, and thus the collapse resistance can be enhanced, by reducing the exposure ( $P[E]$ ) or the vulnerability of the structure ( $P[D|E]$ ) or by increasing its robustness ( $P[C|D]$ ). The exposure of a structure is associated to the abnormal events damaging the structure; the vulnerability depends on the individual structural elements and robustness on global system organization. Starossek and Haberland (Starossek & Haberland, 2010) provided a framework for designing collapse-resistant structures. In addition, design of structures considering the structural traits as shown in Figure 16 can limit the local damage and hence prevent the progressive collapse of structure (NFPA 921, 2008).

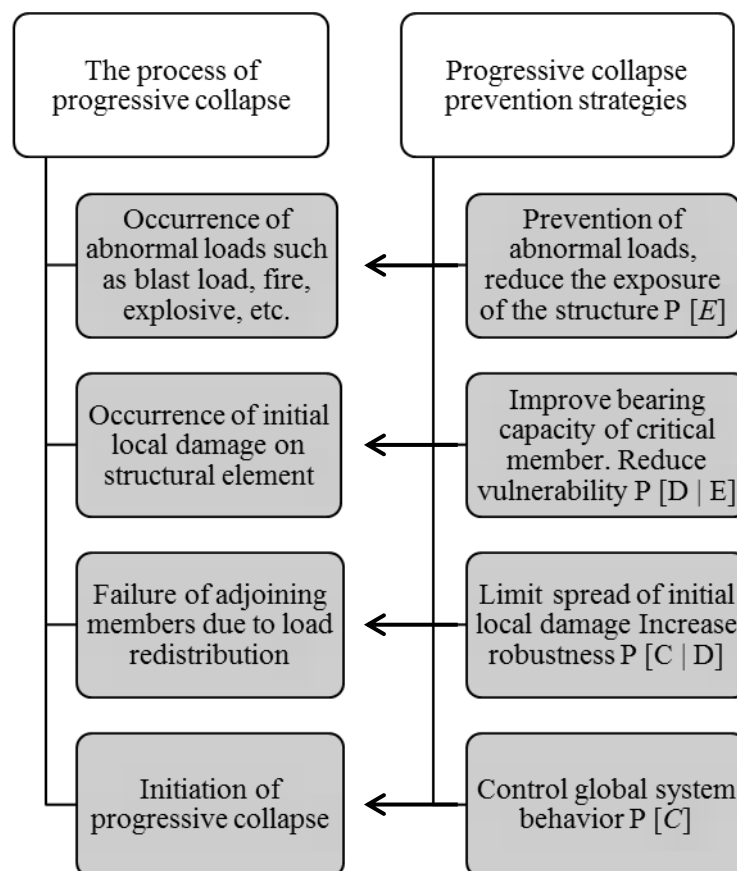
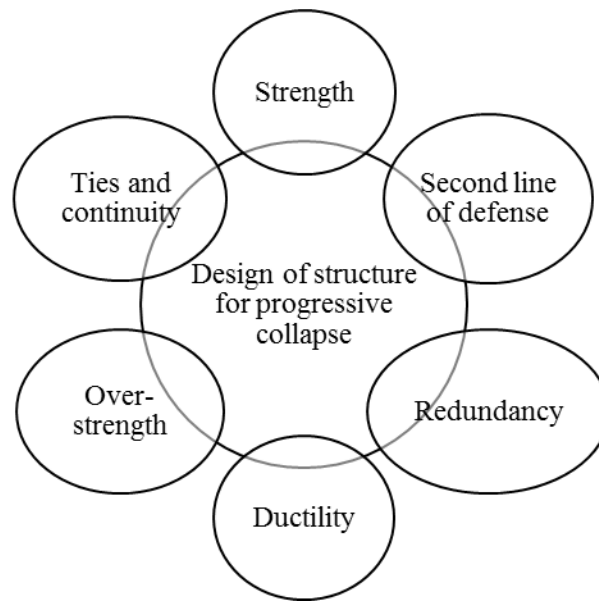

Figure 4: Process of Progressive Collapse and its prevention strategies.



**Figure 5: Design of structure for resisting progressive collapse.**

Figure 17 shows the design methods of progressive collapse of building structures are classified into threat independent design methods and threat dependent design methods. Event control refers to the elimination the possible threads that can trigger the progressive collapse events. Implementing event controls does not necessarily prevent progressive collapse but of course minimize the risks. GSA (GSA, 2003) and UFC (Department of Defense (DoD). Unified facilities criteria (UFC), 2010) discussed Alternate Load Path method (APM) as one of the most common approaches to evaluate structural robustness. APM requires removing the critical load bearing elements to evaluate the collapse resistance and not able to model the loading explicitly (Fascetti et al., 2015). Generally the APM is used in two situations (UFC, 2005): (I) when a vertical load carrying element lack sufficient tie strength, (II) for buildings that require Medium or High level of safety. After the column removal, the axial force just above the failed column is transferred to the adjacent column via beam. Thus the two bays beam above the failed column now acts as single bay, which is more responsible for the redistribution of internal forces (H Wibowo & Lau, 2009). It is observed that the internal forces in structural element not exceeding 30% in columns and 20% in beams can be redistributed to the adjacent elements (Ionita et al, 2010). This method is a threat-independent approach, and therefore, is valid for any possible hazards that may cause collapse (Janssens & O'dwyer, 2010). Specific load resistance approach requires designing the critical load carrying element to remain intact for developing the alternate load paths. The ACI code (ACI 318, 2011) requires a minimum level of structural integrity to be integrated in the structure to enhance the continuity and integrity in the event of column loss.

Tie force indirect methods helps to achieve continuity in structural components and binds the structure to act as a single unit on any unexpected events. In UFC (2005) (UFC, 2005), the indirect method is entirely used for the structures requiring very low level of protection (VLLOP) and for those requiring a low level of protection (LLOP) the indirect method may be supplemented with the alternate load path method.

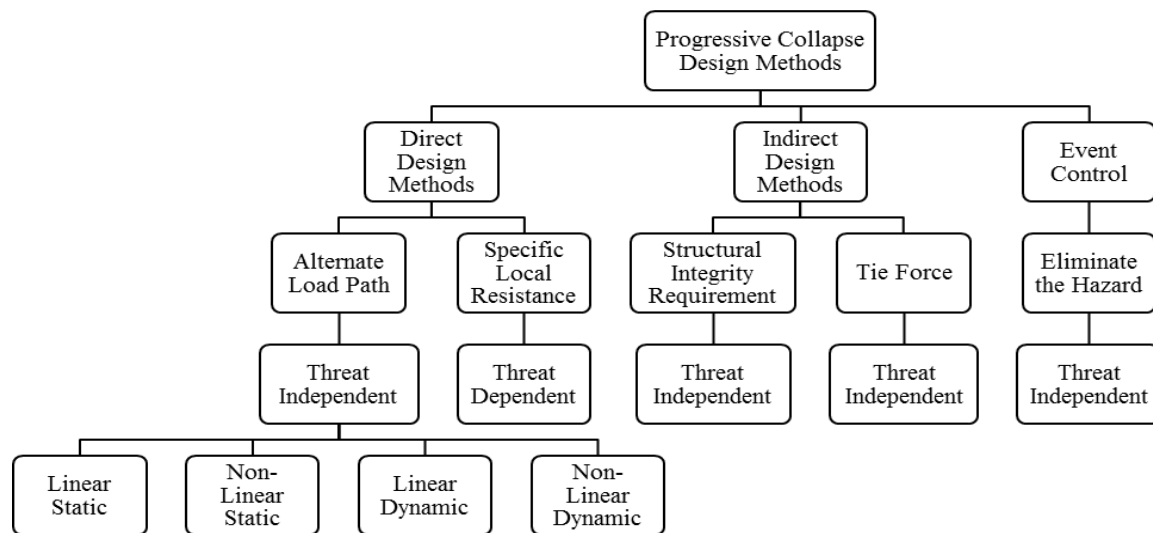

**Figure 6: Design methods of progressive collapse resistance.**

Linear Static, Non-Linear Static, Linear Dynamic and Non-Linear Dynamic are the four alternative analytical procedures as described in DoD (2005) (UFC, 2005) and GSA (2003)(GSA, 2003). The merits and demerits of each analysis procedures are summarized by Marjanishvili & Agnew (S. Marjanishvili & Agnew, 2006).

**Linear Static:** This analysis is only carried out for simple and regular configuration and does not take account of dynamic and nonlinearity effects (H Wibowo & Lau, 2009). This technique involves applying the fully factored load, at one time, to the damaged structure, from which a vertical load carrying structural member has been removed (Janssens & O'dwyer, 2010).

**Nonlinear Static:** This analytic procedure is the advancement of linear static analysis as it includes both geometric and material nonlinearity in its operation (Janssens & O'dwyer, 2010). However the time-dependent effect is not taken into account directly in the analysis (H Wibowo & Lau, 2009). This method requires the application of stepwise addition of amplified vertical loads till the attainment of maximum amplified loads or failure occurs (S. Marjanishvili & Agnew, 2006).

For linear and nonlinear static analysis, an amplified load factor of 2, to account for the dynamic effects has been suggested by GSA (2003)(GSA, 2003) and DoD (2005)(UFC, 2005) as shown in Eq. (1) and (2) respectively.

$$2.0 (D + 0.25L) \quad (1)$$

$$2.0 [(0.9 \text{ or } 1.2) D + (0.5L \text{ or } 0.2S)] \quad (2)$$

**Linear Dynamic:** This method comprises the dynamic amplification effects but does not take account of the effects of material and geometric nonlinearity (S. Marjanishvili & Agnew, 2006). Although their accuracy is much higher than static analysis procedures, this method requires extensive judgment on establishing P-delta and member effects (Janssens & O'dwyer, 2010), and is limited to structures that are supposed to remain in elastic state (S. M. Marjanishvili, 2004) and exhibits large plastic deformations (H Wibowo & Lau, 2009) when event occurs.

**Nonlinear Dynamic:** Nonlinear dynamic analysis is the most accurate approach for performing an alternate path analysis as it takes account of both the geometrical and material nonlinearities (S. Marjanishvili & Agnew, 2006) and plastic behavior of the structure (S. M. Marjanishvili, 2004). Apart from allowing the higher deflection and energy dissipation, this procedure also include time dependent effects caused by the impact of failed portions on the remaining structure in complicated analysis (Kaewkulchai & Williamson, 2006).

Nonlinear dynamic approach uses the following load combinations to analyze the entire structure (ASCE, 2010; UFC, 2005).

$$(0.9 \quad \text{Or } 1.2) D + (0.5L \text{ or } 0.2S) + 0.2W$$

## 5. SUMMARY

The underlying characteristic of progressive collapse is that the initial failure caused by any abnormal events, such as blast, fire, seismic or explosive, extends its magnitude at the final state. For this reason, beams, columns and frame connection should be analyzed and designed in order to provide an alternate path for the redistribution of large loads. Designing a normal building, with improving the detailing, incorporating the tie force approach somehow helps to resist progressive collapse but fails to consider the dynamic effects and the load distribution mechanism. Although APM enhances the ductility, continuity, and energy absorbing

properties, it has been observed as incompetent because only one column is removed at a time during progressive collapse analysis.

This paper explores the most common factors that cause abnormal load to the structures and mechanism of progressive collapse caused by explosive, fire, seismic or impact load with examples. It also discusses progressive collapse provisions in existing codes and guidelines.

It is seen that many buildings collapsed few minutes after the earthquake in Nepal in May 2015, some of the cases may be due to loss of a primary structure element which might have lead to entire collapse of the structures. In our context Nepal, there is no any design provisions developed considering progressive collapse in our building codes as earthquake resistant design is considered mostly to overcome such types of failure.

## REFERENCES

1. ACI Committee 318. Building Code Requirements for Structural Concrete and Commentry, 2011.
2. Alogla K, Weekes L, Augustus-nelson L. A new mitigation scheme to resist progressive collapse of RC structures. *Construction and Building Materials*, 2016; 125: 533–45.
3. ASCE 7-02. Minimum Design Loads for Buildings and Other Structures.
4. ASCE. Minimun Design Loads for Buildings and Other Structures. American Society of Civil Engineers, 2010.
5. British Standard Institute. BS8110. Structural use of concrete, part 1: code of practice for design and construction. United Kingdom, 1997.
6. Brown HA. Evaluation of Missing Member nalyse for Progressive Collapse Design of Steel Buildings and Girder Bridges. University of Delaware, Denver, 2010.
7. Casciati F, Faravelli L. Progressive failure for seismic reliability analysis. *Engineering Structures*, 1984; 6(2): 97–103.
8. Corley WG, Sr. PFM, Sozen M a., Thornton CH. The Oklahoma City Bombing: Summary and Recommendations for Multihazard Mitigation. *Journal of Performance of Constructed Facilities*, 1998, 12(3): 100–12.
9. DoD. Design of buildings to resist progressive collapse. Unified Facilities Criteria (UFC) 4-023-03, 2009.
10. Dusenberry DO, Juneja G. Review of Existing Guidelines and Provisions Related to Progressive Collapse. Simpson Gumpertz & Heger Inc 297 Broadway Arlington, Massachusetts, 02474: 1–31.

11. Ellingwood BR, Smilowitz R, Dusenberry DO, Duthinh D, Lew HS, Carino NJ. Best practices for reducing the potential for progressive collapse in buildings. US National Institute of Standards and Technology (NIST), 2007; 216.
12. European Committee for Standardization. EN 1991-1-7. Eurocode 1: Actions on structures, part 1-7: general actions-accidental actions. Brussels (Belgium), 2006.
13. European Standard. Eurocode-Basis of structural design. EN, 1990; (2002).
14. Fascetti A, Kunnath SK, Nisticò N. Robustness evaluation of RC frame buildings to progressive collapse. *Engineering Structures*, 2015; 86: 242–9.
15. General Service Administration. Alternate path analysis & design guidelines for progressive collapse resistance, 2013.
16. Gross JL, McGuire W. Progressive Collapse Resistant Design. *Journal of Structural Engineering*, 1983; 109(1): 1–15.
17. GSA. Progressive Collapse Analysis and Design Guidelines for New Federal Office Buildings and Major Modernization Projects. US General Services Administration (GSA), 2003.
18. Izzuddin BA, Vlassis AG, Elghazouli AY, Nethercot DA. Progressive collapse of multi-storey buildings due to sudden column loss - Part I: Simplified assessment framework. *Engineering Structures*, 2008; 30(5): 1308–18.
19. Janssens V, O'dwyer D. The Importance of Dynamic Effects in Progressive Collapse. IABSE Symposium Report, 2010; 97(14): 54–61.
20. Jian H, Zheng Y. Simplified Models of Progressive Collapse Response and Progressive Collapse-Resisting Capacity Curve of RC Beam-Column Substructures. *Journal of Performance of Constructed Facilities*, 2014; 28(4): 1–7.
21. Kaewkulchai G, Williamson EB. Modeling the Impact of Failed Members for Progressive Collapse Analysis of Frame Structures. *Journal of Performance of Constructed Facilities*, 2006; 20(4): 375–83.
22. Li Y, Lu X, Guan H, Ren P. Numerical investigation of progressive collapse resistance of reinforced concrete frames subject to column removals from different stories. *Advances in Structural Engineering*, 2016; 19(2): 314–26.
23. Li Y, Lu X, Guan H, Ye L. An Energy-Based Assessment on Dynamic Amplification Factor for Linear Static Analysis in Progressive Collapse Design of Ductile RC Frame Structures. *Advances in Structural Engineering*, 2014; 17(8): 1217–25.
24. Li Y, Lu X, Guan H, Ye L. An improved tie force method for progressive collapse resistance design of reinforced concrete frame structures. *Engineering Structures*, 2011,

- 33(10):2931–42.
25. Li Y, Lu X, Guan H, Ye L. Progressive Collapse Resistance Demand of Reinforced Concrete Frames Under Catenary Mechanism. *ACI Structural Journal*, 2014; 111(5): 1225-34.
  26. Lim NS, Tan KH, Lee CK. Experimental studies of 3D RC substructures under exterior and corner column removal scenarios. *Engineering Structures*, 2017; 150: 409–27.
  27. Marjanishvili S, Agnew E. Comparison of Various Procedures for Progressive Collapse Analysis. *Journal of Performance of Constructed Facilities*, 2006; 20(11): 365–74.
  28. Marjanishvili SM. Progressive Analysis Procedure for Progressive Collapse. *Journal of Performance of Constructed Facilities*, 2004; 18(2): 79–85.
  29. Menchel K. Progressive Collapse: Comparison of Main Standards, Formulation and Validation of New Computational Procedures. PhD Thesis, Faculty of Applied Sciences, Universite Libre De Bruxelles, Bruxelles, 2009.
  30. Naji A. Modelling the catenary effect in the progressive collapse analysis of concrete structures. *Structural Concrete*, 2016; 17(11): 145-151.
  31. National Fire Protection Association NFPA 921. Guide for fire and explosions investigations, 2008.
  32. National Research Council of Canada. National Building Code of Canada, 1975.
  33. Qian K, Li B, Ma J. Load-Carrying Mechanism to Resist Progressive Collapse of RC Buildings. *Journal of Structural Engineering*, 2014; 14: 040141071-14.
  34. Qian K, Li B. Experimental and Analytical Assessment on RC Interior Beam-Column Subassemblages for Progressive Collapse. *Journal of Performance of Constructed Facilities*, 2012; 26(5): 576–89.
  35. Rashidian O, Abbasnia R, Ahmadi R, Mohajeri Nav F. Progressive Collapse of Exterior Reinforced Concrete Beam-Column Sub-assemblages: Considering the Effects of a Transverse Frame. *International Journal of Concrete Structures and Materials*, 2016, 10(4): 479–97.
  36. Sagiroglu S, Sasani M. Progressive Collapse-Resisting Mechanisms of Reinforced Concrete Structures and Effects of Initial Damage Locations. *Journal of Structural Engineering*, 2014.
  37. Sasani M, Bazan M, Sagiroglu S. Experimental and Analytical Progressive Collapse Evaluation of Actual Reinforced Concrete Structure, 2008; 104(11-12): 731–40.
  38. Sasani M, Werner A, Kazemi A. Bar fracture modeling in progressive collapse analysis of reinforced concrete structures. *Engineering Structures*, 2011; 33: 401–9.



39. Shams-AL AZ. Progressive Collapse Analysis of Four Existing Reinforced Concrete Buildings Using Linear Procedure. Eastern Mediterranean University, 2012.
40. Starossek U, Haberland M. Disproportionate Collapse: Terminology and Procedures. *Journal of Performance of Constructed Facilities*, 2010; 24(6): 519–28.
41. Starossek U. Typology of progressive collapse. *Engineering Structures* 2007, 29:2302–7.
42. Tohidi M, Yang J, Baniotopoulos C. Numerical evaluations of codified design methods for progressive collapse resistance of precast concrete cross wall structures. *Engineering Structures*, 2014; 76: 177–86.
43. Tsai MH, Lin BH. Investigation of progressive collapse resistance and inelastic response for an earthquake-resistant RC building subjected to column failure. *Engineering Structures*, 2008; 30(12): 3619–28.
44. UFC 4-023-03. Design of Buildings to Resist Progressive Collapse. Unified Facilities Criteria (UFC), 2003.
45. UFC\_4\_023\_03. Design of structures to resist progressive collapse unified facilities criteria. 25 Jan, 2005.
46. Vlassis, AG. Progressive Collapse Assessment of Tall Buildings. Phd Thesis, Department of Civil and Environmental Engineering, Imperial College London, 2007.
47. Weng J, Tan KH, Lee CK. Modeling progressive collapse of 2D reinforced concrete frames subject to column removal scenario. *Engineering Structures*, 2017; 141: 126–43.
48. Wibowo H, Lau DT. Seismic Progressive Collapse: Qualitative Point of View. *Civil Engineering Dimension*, 2009; 11(1): 8–14.
49. Xu G, Ellingwood BR. An energy-based partial pushdown analysis procedure for assessment of disproportionate collapse potential. *Journal of Constructional Steel Research*, 2011; 67(3): 547–55.
50. Yap SL, Li B. Experimental investigation of reinforced concrete exterior beam-column subassemblages for progressive collapse. *ACI Structural Journal*, 2011; 108(5): 542–52.
51. Yi W-J, He Q-F, Xiao Y, Kunnath SK. Experimental Study on Progressive Collapse-Resistant Behavior of Reinforced Concrete Frame Structures. *ACI Structural Journal*, 2008; 105(4): 433–9.
52. Yu J, Tan KH. Special Detailing Techniques to Improve Structural Resistance against Progressive Collapse. *Journal of Structural Engineering*, 2014; 140(3): 04013077.
53. Yu J, Tan KH. Structural Behavior of RC Beam-Column Subassemblages under a Middle Column Removal Scenario. *Journal of Structural Engineering*, 2013; 139(2): 233–50.