

DESIGN ANALYSIS FOR A HALF-WAVE DIPOLE ANTENNA FOR 2.4GHZ WIRELESS APPLICATION USING CST MICROWAVE STUDIO

Onu, Igochi Praise*¹ and Dr. Orakwue, Stella Ifeoma²

¹M.Sc. Information and Telecommunication Engineering, University of Port Harcourt.

²Lecturer, Dept. of Electrical/Electronics Engineering, University of Port Harcourt.

Article Received on 21/09/2020

Article Revised on 11/10/2020

Article Accepted on 02/11/2020

*Corresponding Author

Onu Igochi Praise

M.Sc. Information and
Telecommunication
Engineering, University of
Port Harcourt.

ABSTRACT

This paper breaks down a simple Half-Wave Dipole Antenna which has been designed and analysed for wireless application using a resonating frequency of 2.4 GHz which most wireless devices operate on. This design was carried out successfully using a simulation tool called CST Microwave Studio. The Return Loss Curve, Bandwidth,

VSWR, Far-Field Directivity and Gain were all observed in this paper.

KEYWORDS: *Half-Wave, Dipole, Return-Loss, VSWR, Directivity, Gain.*

INTRODUCTION

The most usually utilized reception apparatus in transmission is the Dipole Antenna which is utilized for Radio Frequency (RF) transmission. There are a few kinds of dipole reception apparatus, for example, half-wave dipole, hertzian dipole, short dipole, etc. (USNA n.d.). The total length of the antenna wire which is being used as a dipole is half of a wavelength (i.e. $L = \lambda/2$) which is called Half-Wave Dipole Antenna.

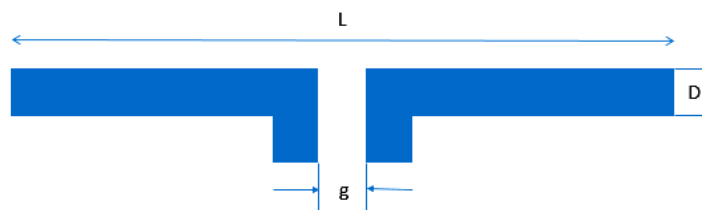

Figure 1: Plane view of Half-Wave Dipole Antenna.

The plane view of a half-wave dipole antenna can be seen in Fig. 1. The antenna has a gap between the two ends for feeding purpose where L is the total length of the antenna, D is the thickness of the antenna and g is the feeding gap. For a half wave dipole antenna, the radiation resistance is 73 Ohms which matched the line impedance (Brown University n.d.). The two parts of the antenna are conductive and can be designed from metal wires.

Design Parameters

In the design of antenna, dimensions can change based of the resonant frequency (Balanis 2005). A resonant Frequency of 2.4 GHz has been chosen and taken into consideration several antenna dimensions is calculated as follows:

Resonant Frequency (f_r) = 2.4 GHz

Wavelength (λ) is obtained using equation 1.

$$\lambda = \frac{c}{f} = \frac{3 \times 10^{11}}{2.4 \times 10^9} = 125\text{mm} \quad \dots\dots\dots (1)$$

Length of half-wave dipole antenna (L):

$$L = \frac{\lambda}{2} = \frac{125}{2} = 62.5\text{mm} \quad \dots\dots\dots (2)$$

Feed gap of the antenna (g):

$$g = \frac{L}{2} = \frac{62.5}{200} = 0.3125 \text{ mm} \quad \dots\dots\dots (3)$$

Radius of Dipole (i.e Thickness of Antenna) (R):

$$R = \frac{\lambda}{1000} = \frac{125}{1000} = 0.125 \text{ mm} \quad \dots\dots\dots (4)$$

From the equations above, the parameters of the designed antenna are calculated using the desired resonant frequency from which the wavelength and half-wave length of the dipole antenna are calculated and the Feed gap and Radius of the dipole antenna are also calculated. All dimensions of the antenna are shown in Table 1.

Table 1: The Dimension of the designed antenna.

Parameter	Value	Unit
Resonant Frequency (f_r)	2.4	GHz
Wavelength (λ)	123	mm
Impedance	73	Ohms
Length of dipole antenna (L)	62.5	mm
Radius of dipole antenna (R)	0.125	mm

SIMULATION AND RESULT

Simulation

The half-wave dipole antenna was designed with the design parameters using CST Microwave Studio. Fig. 2 shows the design structure of the half-wave dipole antenna.

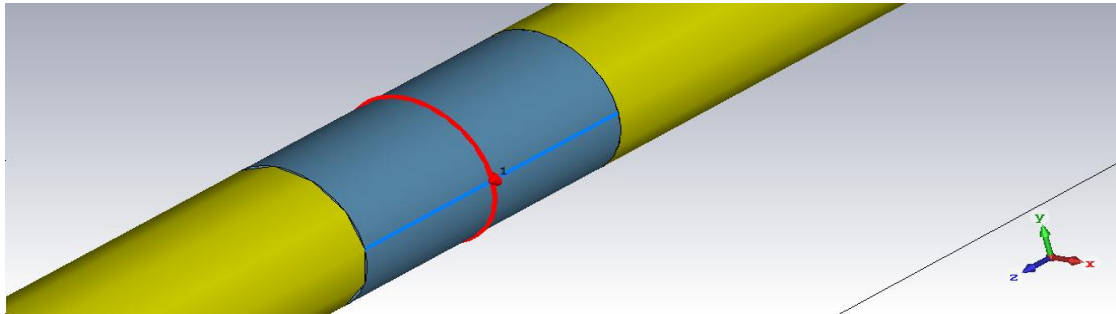

Figure 2: Design of Half-Wave Dipole Antenna.

With the purpose of the dipole antenna centered on wireless application, the range of frequencies has been chosen from 1GHz to 10GHz.

In the simulation, global mesh properties have been optimized. The antenna material used is copper wire, between the two antenna arms, a sheet was inserted with the impedance at 73 Ohms.

RESULTS

After a successful simulation, result has been gotten from different categories which include the Return Loss, the Bandwidth, the Voltage Standing Wave Ratio (VSWR), Directivity and Gain. Fig. 3 shows the Return Loss curve of the antenna.

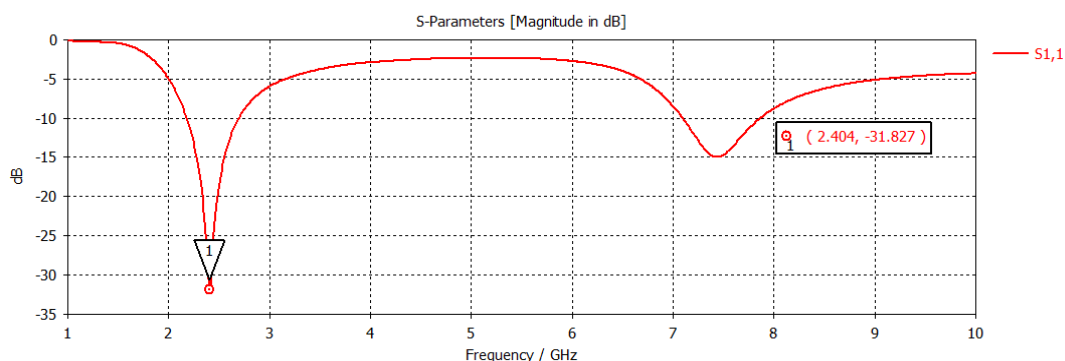

Figure 3: Return Loss Curve for the designed Half-Wave Dipole Antenna.

From Fig. 3, it is found that the antenna is resonating at 2.404 GHz (approx. 2.4 GHz) and the Return Los value has been found as -31.827 dB which is indicated with the notation (1).

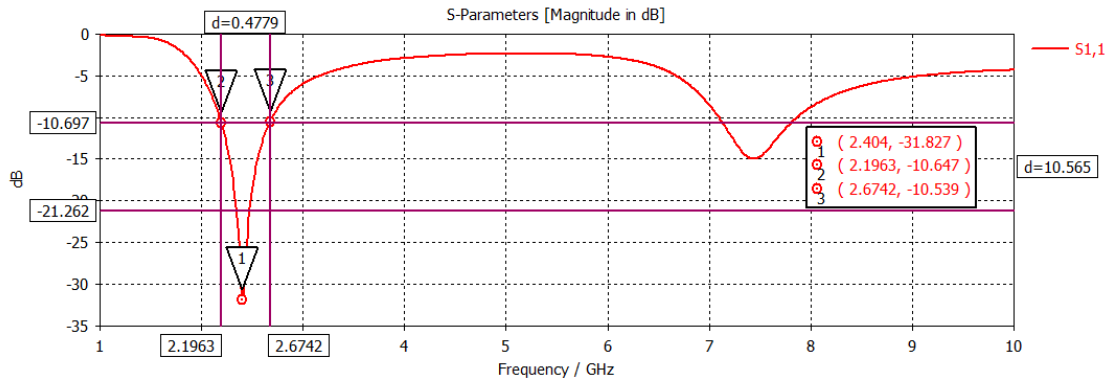

Figure 4: Bandwidth Curve for the designed Half-Wave Dipole Antenna.

From Fig. 4, the bandwidth of the designed antenna is found as 0.4779 GHz and frequency ranges at -10 dB are 2.1963 GHz and 2.6742 GHz with the notation (2) and (3) respectively.

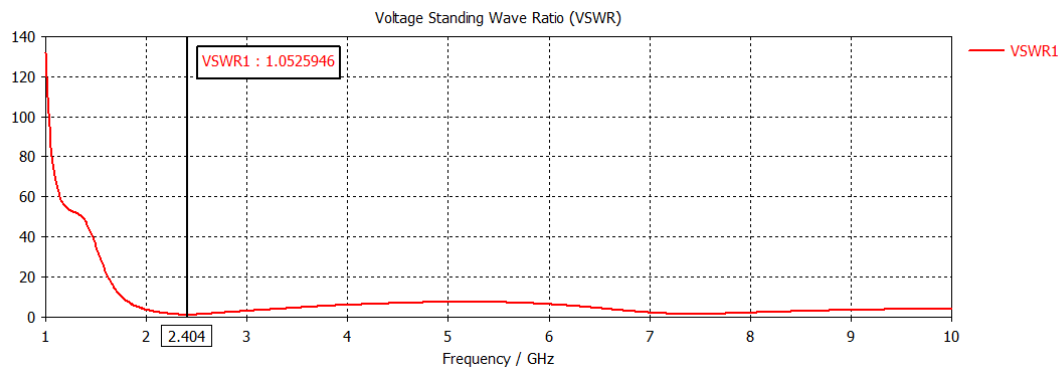

Figure 5: VSWR of the designed Half-Wave Dipole Antenna.

Fig. 5 shows the VSWR of the antenna and is found at 1.0525946 (approx. 1.1) at the resonating frequency of 2.4 GHz. This means that 100% of power will be delivered from the transmitter to the antenna at 2.4 GHz frequency, since the VSWR is 1.

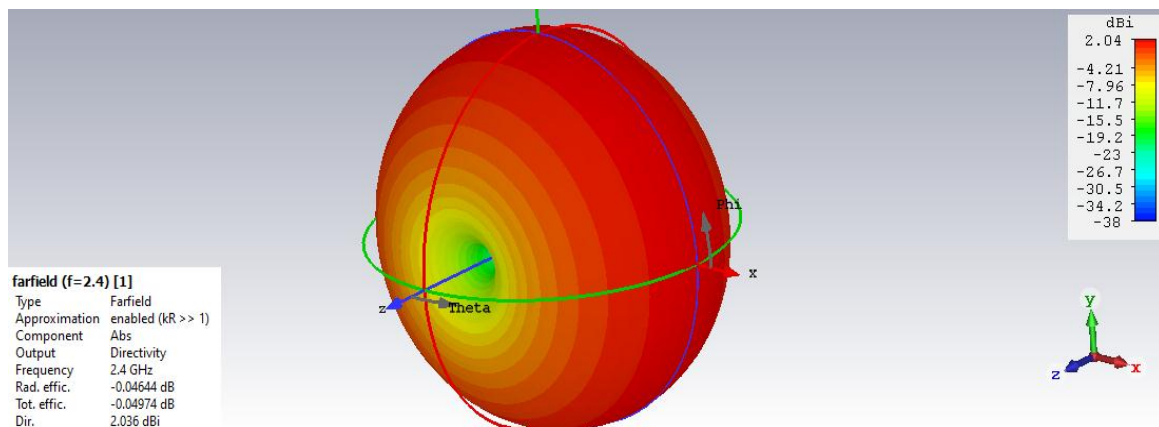

Figure 6: 3-D Radiation Pattern of Directivity for the designed Half-Wave Dipole Antenna.

The Far Field Radiation pattern in Fig. 6 shows the Directivity of the designed antenna which is found at 2.036 dBi which is closely identical to the theoretical ones (Saunders and Zavala 2007).

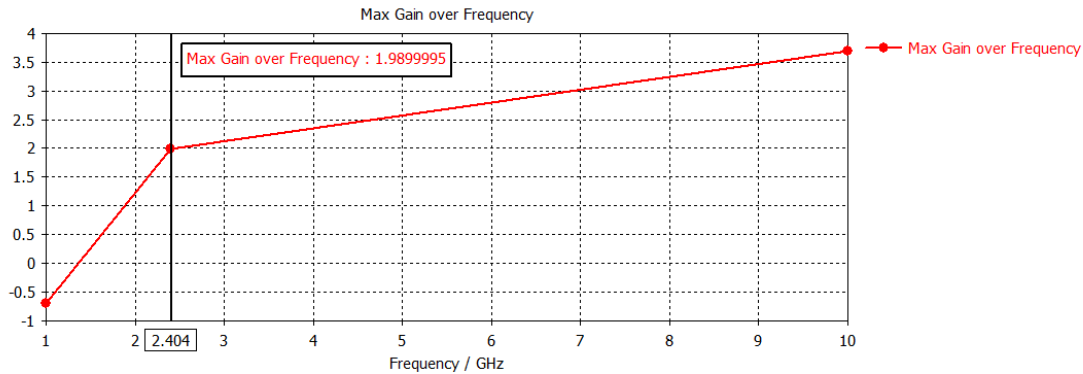

Figure 7: Max. Gain of the designed Half-Wave Dipole Antenna.

From Fig. 7, it is shown that the maximum gain over the resonating frequency is at 1.9899995 (approx. 2).

Table 2: Summary of the simulated resulted is given in Table 1.

Parameter	Value	Unit
Resonant Frequency (f_r)	2.404	GHz
Return Loss	-31.827	dB
Bandwidth	0.4779	GHz
VSWR	1.0525946	
Directivity	2.036	dBi
Gain	1.9899995	dB

CONCLUSION

The main objective of this paper was to observe the several antenna characteristics of a Half-Wave Dipole Antenna used for Wireless Applications. The simulation tool used for the ease of simulation is the CST Microwave Studio. Observed results can be used for practical implementation of this type of antenna. The resonating frequency of 2.404 GHz which is approximately 2.4 GHz is acceptable. The return loss was obtained at -31.827 dB shows the characteristics of reflection coefficient. Bandwidth was observed at 0.4779 GHz (approx. 0.5 GHz) i.e. about 500 MHz which is also good enough for various wireless application. There are other scopes of the parameters which can be improved on by researchers in the future.

REFERENCES

1. Balanis, C. A., “Antenna Theory Analysis and Design”, *John Wiley & Sons, 3rd Edition, USA, 2005*; 182.
2. Brown University, (n.d.): “Antennas II”, *Lecture, 25*: 12.
3. Saunders, S. R., Zavala, A. A., “Antennas and Propagation for Wireless Communication Systems”, *John Wiley & Sons, 2nd Edition, England, 2007*; 77.
4. USNA, (n.d.): “Antenna Fundamentals”, *EE302, 13*: 9.