

DESIGN AND OPTIMIZATION OF SOLAR PANEL/DIESEL GENERATOR/STORAGE BATTERY HYBRID SYSTEM FOR RURAL ELECTRIFICATION

Belete Tekie*

Department of Electrical Power and Control Engineering, School of Electrical Engineering and Computing, Adama Science and Technology University, Adama, Ethiopia.

Article Received on 22/09/2021

Article Revised on 12/10/2021

Article Accepted on 02/11/2021

***Corresponding Author**

Belete Tekie

Department of Electrical Power and Control Engineering, School of Electrical Engineering and Computing, Adama Science and Technology University, Adama, Ethiopia.

ABSTRACT

Hybrid power systems based on renewable energy sources, especially photovoltaic energy with diesel generator, are an effective option to solve the power-supply deficiency problem for remote and isolated areas far from the national grids. In this paper, photovoltaic-diesel generator-battery bank-converter have been simulated and optimized for the rural community of Dasaanach among the woreda of south Omo Zone in SNNPR of Ethiopia. Primary energy demand of the community is 325kwh/day with peak load of 54kw and the deferrable energy demand of 16kwh/day with peak load of 2.6kw was involved

during optimal design of hybrid power system. HOMER software has been used to design the optimal combination, test and simulate the off-grid system. Accordingly, solar energy is considered as primary sources to supply electricity directly to the load and to charge battery bank when there is excess solar energy generation. However, in peak load times diesel generator could also be engaged. The load has been suggested for house hold loads (lighting, television, radio, local food (enjera) baking), commercial load (flour milling machines), community load (school, health clinic) and deferrable load (water pumping). The Integration of the hybrid system is to electrify residential houses and their surrounding in order to reduce the need for fossil fuel leading to an increase in the sustainability of the power supply. The study shows that a 60kw solar, 25kw diesel and 80 units of battery with least cost of energy \$0.295/kwh and minimum net present cost \$381,457 is an optimal combination to provide electricity for the community.

KEYWORDS: HOMER Hybrid system Primary load Deferable load NPC COE Rural electrification Renewable energy.

1 INTRODUCTION

Electricity is the backbone and imperative condition for a human life.^[1] Electricity affects every part of people lives and it is vital to the smooth functioning of a healthy economy and to ensure a healthy population. To generating electricity, energy generating resources will be available and secure. Based on their availability and security, energy resources can be distinguished as fossil fuels that will be exhausted by exploiting them and the renewable energy that is sustainable but needs further technical improvement to be used efficiently.^[2] Due to that, the adoption of an off-grid stand-alone RES constitute a useful option for electricity inadequacies in rural area of the developing countries in which the evolution in national grid extension continue to be slower than the population growth.^[1,14]

The hybrid integration of PV-battery-diesel systems is economically feasible in many cases for electric energy supply in isolated areas where the electric utility is not available.^[3,12] PV-Diesel system has greater reliability for electricity production than a PV-only system or diesel-only system. It means that hybrid power systems have greater flexibility, higher efficiency and lower costs for the same quantity of energy production. In addition, the integration of PV system with battery storage and diesel unit as a backup system provides a reduction in the operational costs and emitted air pollutants to the atmosphere.^[4,13]

2 Hybrid system

A hybrid renewable energy system is a system in which two or more supplies from different renewable energy sources (solar-thermal, solar photovoltaic, wind, biomass, hydropower, etc.) are integrated to supply electricity or heat, or both to the same demand.^[4-6] Because the supply pattern of different renewable energy sources intermittent but with different patterns of intermittency, it is often possible to achieve a better overall supply pattern by integrating two or more sources. Sometimes also it including a form of energy storage. In this way the energy supply can effectively be made less intermittent, or more firm.^[6]

The type of the hybrid system and its configuration depend mainly on the availability of the renewable source in the location selected for installing hybrid system. For the Ethiopian case, the average daily solar radiation intensity on a horizontal surface is about 5.26 kWh/m² while the total annual sunshine hours amounts to about 3000hours.

3 Solar radiation estimation

For any solar based system design, the most important factors are the position of the sun in the sky, the slope and orientation of a collecting surface, and obstruction and reflection properties of neighboring structures.

The value of each parameters which used to estimated solar radiation of the site are formulated as follows:

$$\delta_s = \frac{23.45^\circ \sin[360(n_d + 284)]}{360} \quad (1)$$

Where:

δ_s : solar declination angle ($^\circ$)

n_d : day number of the year starting at January 1st as 1

$$\omega_s = 15^\circ \times (t_s - 12) \quad (2)$$

Where:

t_s : local solar time in hours.

ω_s : solar hour angle ($^\circ$)

$$t_s = t_c + \frac{\lambda}{15} - z_c + E \quad (3)$$

Where:

t_s : Solar time [hr]

t_c : The local time accounted to the center (middle) of the time step [hr]

E : Equation of time in hour

λ : Longitude [$^\circ$]

z_c : Time region (zone) to east of Greenwich Meridian Time (GMT) [hr.]

$$E = 3.82(0.000075 + 0.001968\cos B - 0.0032077\sin B - 0.014615\cos 2B + 0.04089\sin 2B) \quad (4)$$

$$B = 360^\circ \frac{(n - 1)}{365} \quad (5)$$

Where: n : day of the year starting with January 1st as 1 through 365.

$$\sin(\gamma_s) = \frac{\cos \delta_s \sin \omega_s}{\cos(\alpha_s)} \quad (6)$$

Where: γ_s : solar azimuth angle ($^\circ$)

α_s : solar altitude ($^\circ$)

The sunset/sunrise angle is given by

$$\omega_s = \cos^{-1}(-\tan(\phi) \tan(\delta)) \quad (7)$$

Where: ϕ : Latitude ($^{\circ}$)

The extraterrestrial irradiance on a surface at normal incidence (G_{on}) may be expressed as:

$$G_{on} = G_{sc} \left[1 + 0.003 \cos \frac{2 \times \pi n_d}{365} \right] \quad (8)$$

Where:

G_{on} : The extraterrestrial normal radiation [kW/m^2]

G_{sc} : The solar constant= 1.367 [kW/m^2]

$$G_o = G_{on} \cos(\theta_z) \quad (9)$$

G_o : The extraterrestrial horizontal radiation [kW/m^2]

θ_z : zenith angle

The whole daily extraterrestrial radiation, H_o from the sun rise to sunset can be calculated as follows:

$$H_o = \frac{24 \times 3600 \times G_{sc}}{\pi} \left(1 + 0.033 \times \cos \left(\frac{360 n_d}{365} \right) \right) \times \left(\cos \phi \cos \delta \sin \omega_s + \frac{\pi \omega_s}{180} \sin \phi \sin \delta \right) \quad (10)$$

n_d : Day number starting from January 1st as 1

G_{sc} : 1367 W/m^2 , the solar constant

ϕ : Latitude of the location (4.45°)

δ : Declination angle ($^{\circ}$)

ω_s : Sunset hour angle ($^{\circ}$)

$$\frac{H}{H_o} = a + b \frac{n}{N_s} \quad (11)$$

Where: H : monthly average daily radiation on horizontal surface (MJ/m^2)

H_o : monthly average daily extraterrestrial radiation on a horizontal surface (MJ/m^2)

N_s : the maximum possible daily hours of bright sunshine given by equation

n : monthly average daily number of hours of bright sunshine

a and b are regression coefficients having average value of $a=0.30$ and $b=0.50$.^[7,14]

The day length, N_s , is the maximum possible daily sunshine hour is

$$N_s = \frac{2}{15} \omega_s \quad (12)$$

3.1 Solar energy potential in ethiopia

Ethiopia receives 4.55 to 6.5 $\text{kWh/m}^2/\text{day}$ annual average of solar isolation throughout the country. This varies significantly during the year, ranging from a minimum of 4.55 kWh/m^2

in July to a maximum of 6.55 kWh/m² in February and March. Other literatures describe the yearly average radiation to be in the range from 4.25 kWh/m² in the areas of Itang in the Gambella regional state (western Ethiopia) to 6.25 kWh/m² around Adigrat in the Tigray regional state (northern Ethiopia).^[2, 8-9]

3.2 Solar energy potential of the selected site

The assessment of the potential for solar radiation of the selected area is done by taking data from different sources. These are National Metrological Service Agency of Ethiopia (NMSA), NASA, and as well as data assessed by Mulugeta and Drake for the regions of the country. At the first approach, the data taken from the National Metrological Service. Solar resource raw data input to the software is the average global horizontal radiation measured for five consecutive years starting from 2011. But as it can be seen from the table 1, the data of 2014 and 2015 are incomplete, so it is better to take the rest of the years then converted into solar radiation using Angstrom Radiation Sunshine Relation.^[10]

Table 1: Sun shine duration of the site from NMSA.

Year	Month											
	Jan	Feb	Mar	Apr	May	Jun	Jul	Aug	Sep	Oct	Nov	Dec
2011	5.4	7.6	5.1	6.7	5.5	2.1	3.9	3.4	3.5	4.5	3.5	6.1
2012	8.7	8.6	7.1	4	4.7	3	3.1	3.6	3.3	5.8	5.2	5.4
2013	6.4	6.3	3.6	3.9	3.4	1.6	2.7	4	4.32	4.7	7.3	7.8
2014	7.5	6.7	6	5.5	4	2.8	X	X	X	X	X	X
2015	8.8	8.32	7.3	4	3.9	1.7	3.1	6.2	6.1	X	X	X

The value for the coefficients a and b which are used to calculate average solar radiation (H) varies with location, and hence the approximate values for the selected site are taken to be 0.30 and 0.50 for a and b respectively.^[10] Hence the average solar radiation data is analyzed using these values and H_0 . Finally, this result is compared with the data taken from NASA and it is found that the annual average solar radiation obtained from NMSA is 5.16KWh/m² and from NASA is 5.97KWh/m². In this study, it prefers to use data obtained from NASA to module the hybrid system due to low value of calculated average radiation and incomplete data record and measure from NMSA. The monthly solar radiation data required from NMSA is given in MJ/m² therefore, it should have converted to kwh/m² by a factor of 277.78wh/m². Using the above equations and table 2 below calculate the values of required parameter used in hybrid power system design.

Table 2: analysis of monthly average solar radiation in MJ/m² for 2011.

n	ω	ϕ	δ	N	360N/365	Cos(360n/365)	Cos(ϕ)	Cos(δ)	$\frac{\varepsilon}{180}$	Sin(ω)	Sin(δ)	Sin(ϕ)	H _o (MJ/M ²)	H _o MJ/m ²	Month
5.4	88.29	4.45	-20.9	11.8	11.6	0.979	0.997	0.93	1.54	0.9996	-0.357	0.078	31	16	Jan
7.6	88.97	4.45	-13.0	11.9	11.7	0.979	0.997	0.97	1.55	0.9998	-0.225	0.078	37	23	Feb
5.1	88.1	4.45	-2.4	11.7	11.5	0.979	0.997	0.99	1.53	0.9994	-0.042	0.078	36	19	Mar
6.7	90.74	4.45	9.4	12.1	11.9	0.978	0.997	0.98	1.58	0.9999	0.1633	0.078	39	23	Apr
5.5	91.52	4.45	18.8	12.2	12.0	0.978	0.997	0.94	1.59	0.9996	0.3222	0.078	39	21	May
2.1	91.9	4.45	23.1	12.3	12.1	0.977	0.997	0.92	1.60	0.9994	0.3923	0.078	37	14	Jun
3.9	91.73	4.45	21.2	12.2	12.0	0.978	0.997	0.93	1.60	0.9995	0.3616	0.078	38	18	Jul
3.4	91.04	4.45	13.2	12.1	11.9	0.978	0.997	0.97	1.59	0.9998	0.2283	0.078	39	17	Aug
3.5	90.17	4.45	2.2	12.0	11.8	0.979	0.997	0.99	1.57	0.9999	0.0384	0.078	39	17	Sep
4.5	89.25	4.45	-9.6	11.9	11.7	0.979	0.997	0.98	1.56	0.9999	-0.1668	0.078	37	18	Oct
3.5	88.47	4.45	-18.9	11.8	11.6	0.979	0.997	0.94	1.54	0.9996	-0.3239	0.078	35	16	Nov
6.1	88.11	4.45	-23.0	11.7	11.5	0.979	0.997	0.92	1.53	0.9994	-0.3907	0.078	34	19	Dec

Table 3: Monthly average solar radiation of Dasaanach site in Kwh/m².

Year	Jan	Feb	Mar	Apr	May	Jun	Jul	Aug	Sep	Oct	Nov	Dec
2011	4.4	6.4	5.3	6.4	5.8	3.9	5	4.7	4.7	5	4.4	5.3
2012	5.8	6.9	6.1	5.0	5.3	4.4	4.4	5.0	4.7	5.6	5.0	5.0
2013	5.0	5.8	4.4	5.0	4.7	3.9	4.4	5.0	5.3	5.0	5.8	6.1
Monthly average	5.1	6.4	5.3	5.5	5.3	4.1	4.6	4.9	4.9	5.2	5.1	5.5
Annual average 5.16												

The size of PV array required for the site can be calculated as

$$PV\ array(wp) = \frac{E_{tot}\ (wh/d)}{SPH(wh/d) \times Beff \times PVder} \quad (13)$$

Where:

SF: Safety factor

Etot: Total Daily energy demand (wh/d) SPH: Solar Peak Hour (h/d). = 5.97

Beff: Battery efficiency (%) =90%

PVder: PV derating factor (%) which takes in account = 80%

The YINGLI SOLARYLxxxD-36B (xxx=Pmax) solar technology solar

The YINGLI SOLARYLxxxD-36B (xxx=Pmax) solar technology solar 320Watt poly/multi crystalline module is selected for the purpose of this work. It has atypical characteristics under Standard test conditions (irradiance of 1000W/m², Air mass of 1.5G solar spectrum and effective cell temperature of 250C).

4 Diesel generator

Diesel generators are important in renewable energy hybrid systems to improve the quality and the availability of the electricity supply. Since diesel generators are dispatchable they can be used to supply the load when the energy productions from the renewable sources are low or the state of the charge of the battery bank is not sufficient for supplying the load. However, the operating and maintenance cost of a diesel generator is relatively high as it requires a continuous supply of fuel (diesel), and frequent maintenance of the machine throughout its operating life.

A back up diesel generator can be connected to the hybrid system to provide electric energy for peak loads which can't be covered by this hybrid system if a permanent electric power supply is required or in case of incapability of the renewable sources to supply the load.

In this study, Cummins diesel generators used and its fuel consumption curve and the efficiency curve equation is depicted as shown below respectively.

$$F = F_o \cdot Y_{gen} + F_1 \cdot P_{gen} \quad (14)$$

Where:

F_o: The fuel curve intercept coefficient [units/hr/kW]

Y_{gen}: Fuel curve slope [units/hr/kW]

F₁: Rated capacity in [kW]

P_{gen}: Electric output in [kW]

$$\eta_{gen} = \frac{3.6 \times P_{gen}}{m_{fuel} \times LHV_{fuel}} \quad (15)$$

Where:

η_{gen}: Generator efficiency

m_{fuel}: The mass flow rate of fuel [kg/hr]

LHV_{fuel}: The lower heating value [MJ/kg]

P_{gen}: The electrical output [kW]

1 kWh = 3.6 MJ

5 Energy Storage-Battery Bank

To guarantee reliable and continual electricity supply to stand-alone PV system, batteries are need for energy storage. Thus, batteries are purposely used to store excess energy for later use. The batteries in most common use in hybrid systems are the deep-cycle lead acid type as Present options cause of availability and cost effectiveness.

Depending on the energy available from the renewable sources and the load power requirement the SoC of a battery can be calculated from the following equations.^[2,15]

Battery charging

$$SOC(t) = SoC(t-1) \times (1 - \sigma) + \eta_B \left(E(t) - \frac{E_{L(t)}}{\eta_{inv}} \right) \quad (16)$$

Battery discharging;

$$SOC(t) = SoC(t-1) \times (1 - \sigma) + \eta_B \left(\frac{E_{L(t)}}{\eta_{inv}} - E(t) \right) \quad (17)$$

Where;

SoC (t): is the state of charge of the battery bank at the time t

SoC (t-1): is the state of charge of the battery bank at the time t-1

σ : is the hourly discharge rate

$E(t)$: is the total energy generated by the renewable systems (PV)

$EL(t)$: is the load demand at time t

η_{inv} : is the inverter efficiency

The storage capacity of a battery also calculated according to the following relation.^[2,6,11]

$$C_{wh} = \frac{E_L \times AD}{\eta_{inv} \times \eta_B \times DOD} \quad (18)$$

Where:

C_{wh} : is the storage capacity of the battery expressed in (Wh)

EL : is the average daily load energy expressed in (kWh/day)

AD : is the daily autonomy

η_{inv} : is the inverter efficiency expressed in (%)

η_B : is the battery efficiency expressed in (%)

DOD : is the depth of discharge of the battery.

In this study Surratte 6CS-25PS battery selected which cost around \$ 1400 and its properties are given in the table 3.5 below.

Table 4: Properties of Surratte 6CS-25PS battery.

Nominal voltage	6 V
Around trip efficiency	80 %
Min. State of charge	40 %
Nominal capacity	1156 Ah
Maximum discharge current	41 A

5.1 Charge controller Modeling and Sizing

Charge controller is an essential component in hybrid systems where a storage system is required. It protects the battery against both excessive overcharge and deep discharge. So, charge controller is modeled by its efficiency where its output is.^[6,11]

$$P_{PVR} = P_{PVout} \times \eta_{PVR} \quad (19)$$

Where:

P_{PVR} : is the output power of the PV charge controller,

P_{PVout} : is the PV panel output power,

η_{PVR} : is the efficiency of the PV charge controller.

5.2 Bidirectional inverter Modeling and Sizing

A bidirectional inverter is essential in the hybrid system where a storage system and a backup diesel generator are involved in the system. It can transfer power simultaneously in both directions. In a charger (rectifier) mode of operation, the output of the bidirectional inverter can be formulated as follows:

$$P_{DCinv} = G_{out} \times \eta_{DCinv} \quad (20)$$

Where:

P_{DCim} : is the output power of the bidirectional inverter in its rectifier mode,

P_{Gout} : is the diesel generator output power, η_{dcim} : is the efficiency of the bidirectional inverter in its rectifier mode.

In an inverter mode of operation, the output of the bidirectional inverter can be formulated as:

$$P_{invm} = P_{DCB} \times \eta_{invm} \quad (21)$$

Where:

P_{invm} : is the output power of the bidirectional inverter in its inverter mode,

P_{DCB} : is the DC bus power,

η_{InvM} : is the efficiency of the bidirectional inverter in its inverter mode

6 Modeling of hybrid system using homer

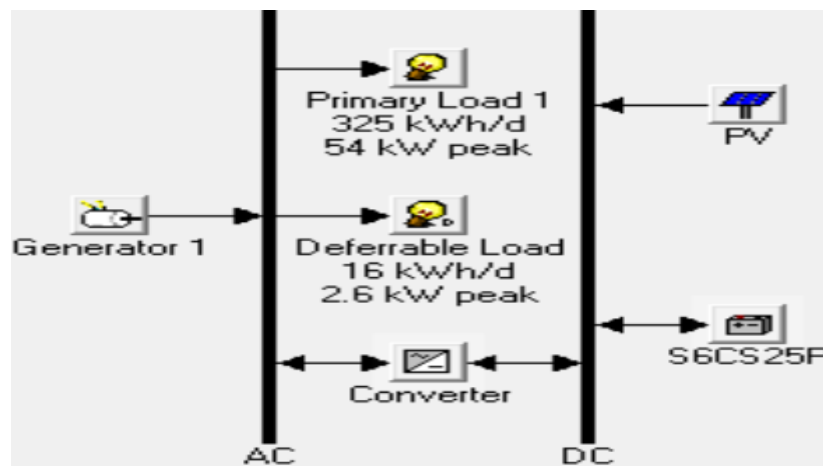

Figure 1: HOMER modeling of hybrid power system set-up.

It has three main functions:

- Simulation (Hourly energy balance)
- Optimization
- Sensitivity Analysis

7 Energy demand of the village

7.1 Profile of the village under study

The Dassenach are an ethnic group of Ethiopia, Kenya and Sudan. Their main homeland is in the Debub Omro Zone of the Southern Nations, Nationalities, and People's Region of Ethiopia, around the North end of Lake Turkana. There are a number of variant spellings of Daasanach, including Dassenach and Dassenach. Daasanach is the primary name given in the Ethnologies language entry.

7.2 Energy Demand Assessment and Load estimation of the village

The term loads refer to a demand for electric or thermal energy, if any. Three types of loads can be modeled using HOMER: primary load which is electric demand that must be served according to a particular schedule, deferrable load which is electric demand that can be served at certain period of time, the exact timing is not important and thermal load which is demand for heat. In this paper the electric load demand of the village community is divided in to the following four major categories like: Household/domestic loads: - which includes lighting, TV, Radio, and baking appliances etc.

Commercial loads: - Flour milling machine.

Community loads: - Which consists of elementary school lighting, desktop computer, and printer, health clinic which includes vaccine refrigerator, communication radio, television, microscope, computer and printer.

Deferable load: Water pump

The study performed electricity load estimation of the village for 834 household with average of five to six family members per household.

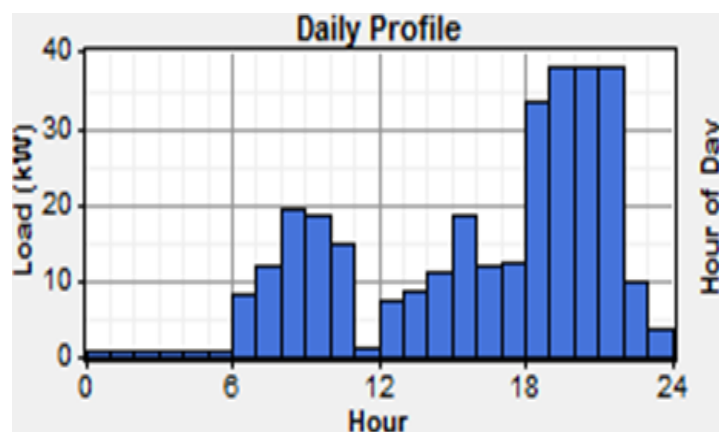

Figure 2: Daily primary load demand profile of the village.

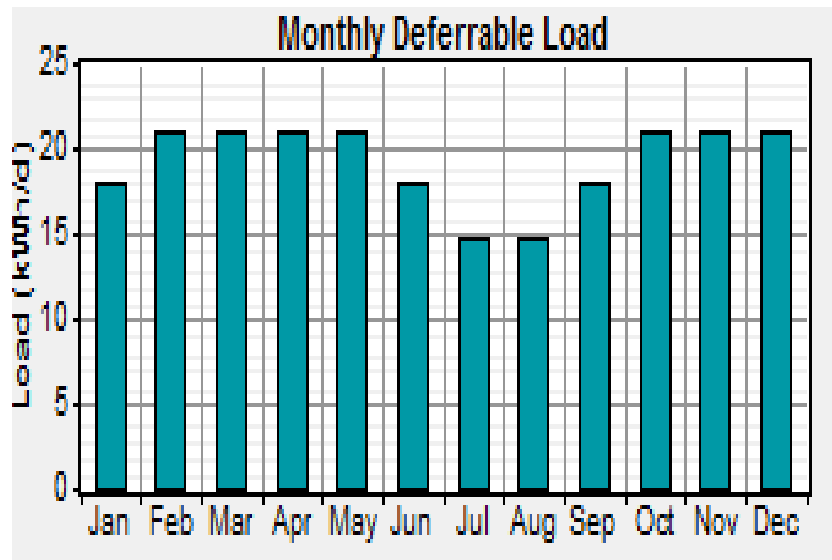

Figure 3: Deferable load profile.

8 RESULT ANALYSIS AND DISCUSSION

All possible hybrid system configurations are listed in ascending order according to their Total net present cost (NPC). The best possible combination of solar PV, DG, Batteries and Converter in the first row of the table 5 is able to fully meet the village load demands at the lowest cost, and the next best possible combination is in the second row of the table 5, includes the solar PV, Batteries and Converter. The simulation software (HOMER) provides the results in terms of optimal systems and the sensitivity analysis. The optimal system configuration for the first case is 60 kW PV, 25kW DG, 80 S6CS 25P batteries and 20kW converter with a dispatch strategy of load following.







As indicated in Figure 2 of the daily village load profile, the maximum load demand will cover in between 18hr to 22hr which is around 38.075kW. But this peak power is increased to 54 kW due the random variability of 5% for day to day and 10%-time step to time step as to be more realistic load demand growth. The generate the extra power of 25 kW required during the peak hours.

This system is considered at \$ 0.63/L of current diesel price and 5.97kwh/m²/day of solar radiation for the PV.

Table 5: Categorized simulation result comparison of three least cost-effective scenarios.

Global Solar (kWh/m²/d) 5.97 Diesel Price (\$/L) 0.63

Double click on a system below for simulation results. Categorized Overall

	PV (kW)	DG (kW)	S6CS25P	Conv. (kW)	Disp. Strgy	Initial Capital	Operating Cost (\$/yr)	Total NPC	COE (\$/kWh)	Ren. Frac.	Capacity Shortage	Diesel (L)	DG (hrs)	Batt. Lf. (yr)
  	60	25	80	20	LF	\$ 204,583	16,569	\$ 381,457	0.295	0.68	0.04	20,577	4,111	12.0
 	50	35		20	LF	\$ 116,817	35,362	\$ 494,302	0.391	0.41	0.09	54,246	8,367	
	90		240	40	CC	\$ 416,000	9,584	\$ 518,309	0.407	1.00	0.08			12.0

Based on the HOMER modeling, the optimal system for Dasaanach village in table 5 first row, a hybrid solar PV/diesel /storage battery, with 60 kw of solar power, 25kw of diesel generator, 80unit of SC6SS25P batteries and 20 kw bi-directional inverter are required power supplied for the selected village where diesel generator runs in load following (LF)strategy. This “optimal” system uses 68% renewable energy, 32% diesel generator and the cost of electricity is \$0.295/kwh.

All of the power schemes remain producing electricity throughout the year no power unit is producing peak load. However, diesel generator runs regularly the whole year due to high nighttime peak load.

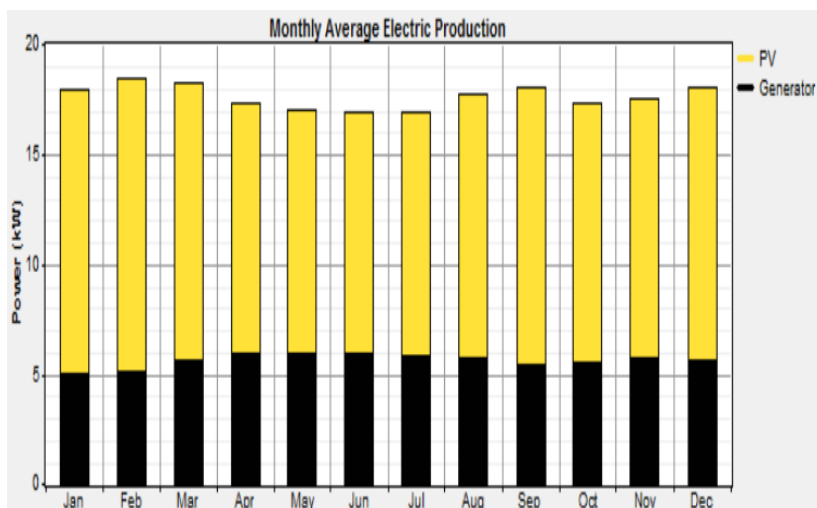
**Figure 4: Share of electricity generation from the optimum system with a 68% RE(PV).**

The total power generation of this power system setup is 154,345kWh/year, whereas the total electric power consumption of the AC load is about 115,421kWh/year that is (95%) of the electricity consumed by AC primary load and the remaining 5,839kWh/year (5%) is for deferrable load with an excess electricity of 10.6%, a capacity shortage of (4.2%) and unmet load of (2.6%) was experienced during the year.

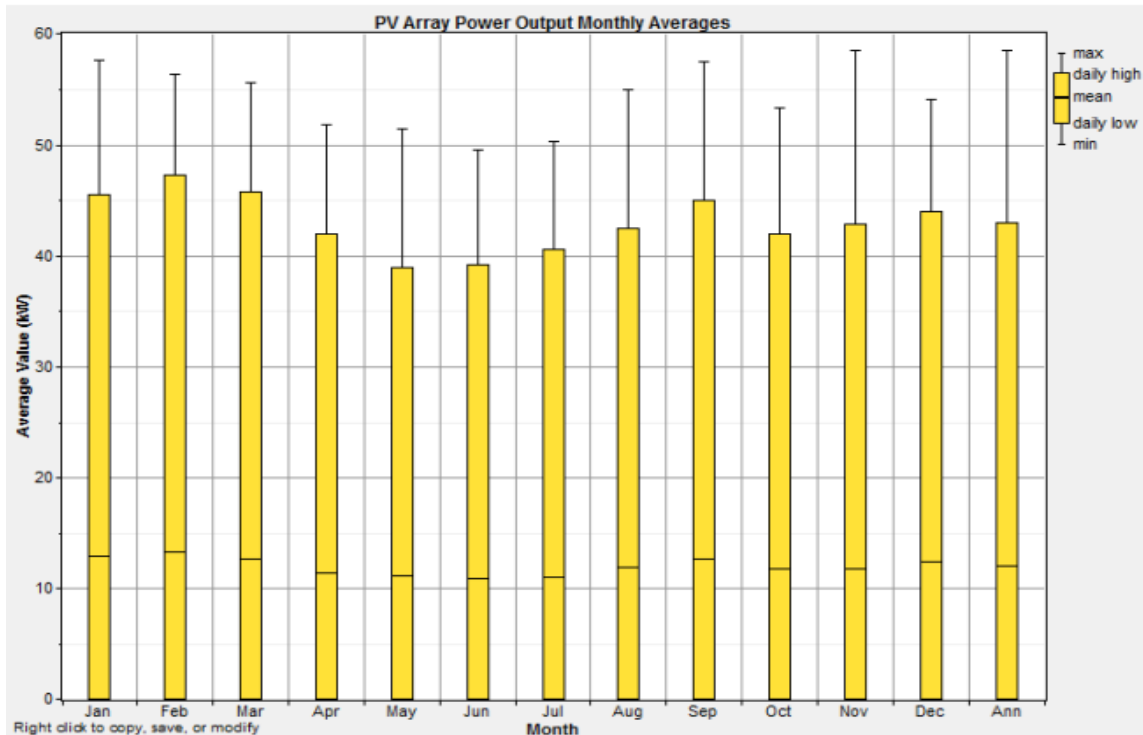

Figure 5: PV power productions with the 68% renewable contribution.

As it can be seen from the figure 5, high solar radiation striking the earth's surface in the month of February but May till end of June PV power generation is lower below 40kW due to cloud coverage of the clear sky. The rated power output PV is 60kW when sky is clear enough, and during no sun time the minimum power output is 0kW.

System load variation and continued run of generator at lower loads depicts poor diesel engine performance. In the figure 6 and 7 below shows Diesel generator power production distribution largely in the evening time because demand is higher than the energy stored in the battery. A 25kW rating capacity diesel generator contribution in hybrid power system generates with mean power output of 12kW and minimum output of 7.5kW.

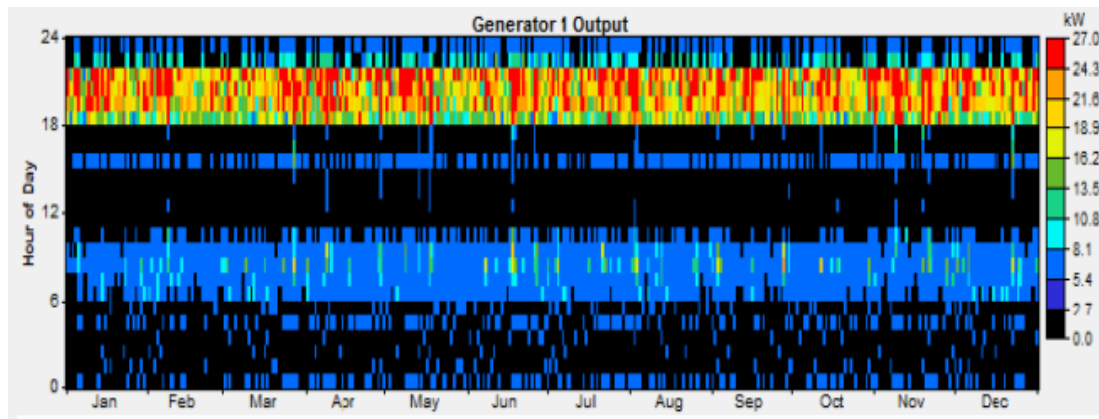

Figure 6: Diesel generator output power.

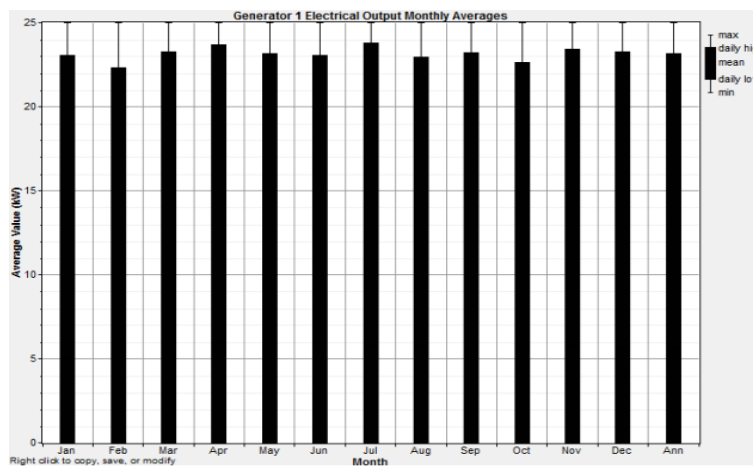

Figure 7: Diesel generator power production monthly average.

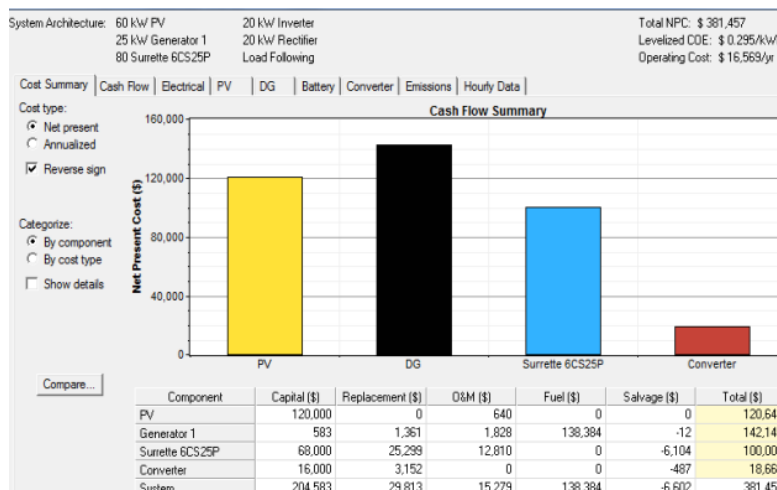

Figure 8: Cash flow summary in terms of NPC by component type.

Cost summary of the above figure 8 clear shown that the initial cost of diesel generator has got low cost to purchase but because of higher fuel consumption, the first expensive cost draw from diesel generator which is around \$142,145 where as large contribution is from PV

which costs \$120,641. Battery got the third one with it costs \$100,006 followed with converter with a cost of 18,666. The percentage share of individual components is described by chart as shown below.

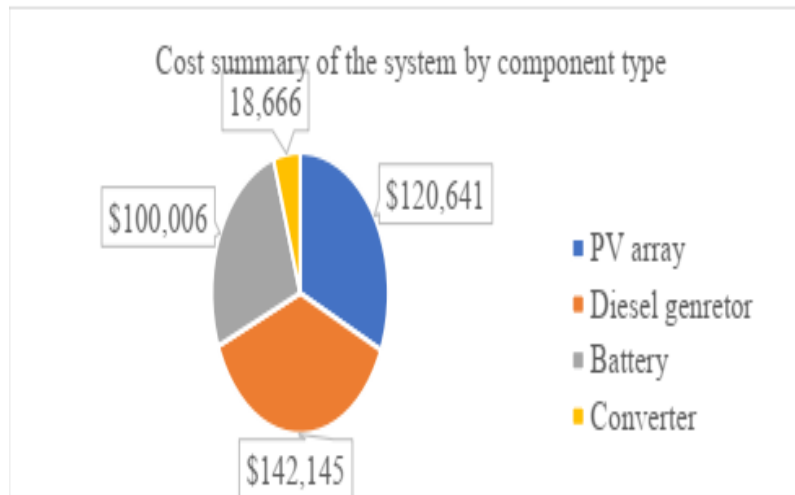

Figure 9: Cost summary of the system by component type.

The figure 10 below displays cost break down cost summary of the components by cost type with 68% renewable fraction hybrid power scheme. It is clearly seen from the graph the total capital cost, NPC cost and cost of energy of the optimal configuration of the hybrid system is calculated by the HOMER software to be \$204,583 and \$381,457 with COE of 0.295\$/kwh respectively.

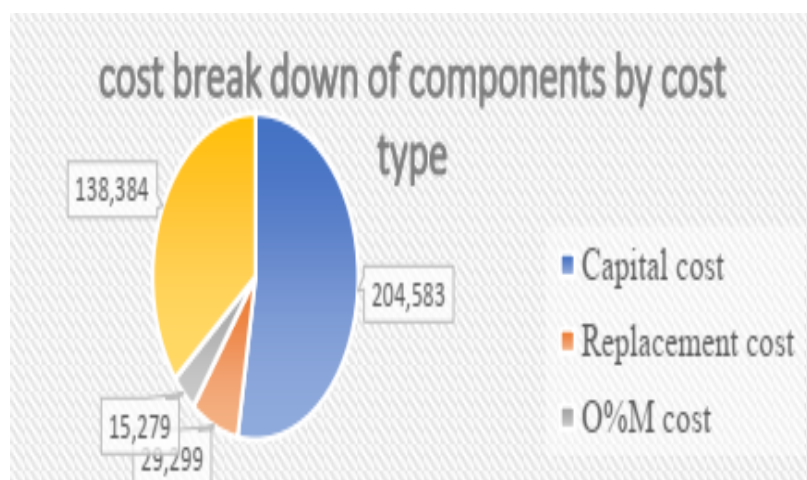

Figure 10: Cost breakdowns of components by cost type.

9 Sensitivity results consideration

Sensitivity is a measure of how the optimal integration of components changes for any parametric variations in the lifelong of the system. The HOMER software simulates all the systems in their respective search space for each of the sensitivity values.

A feasible system is defined as the hybrid system which meet the required load under certain constraint. The software eliminates all infeasible systems and presents the results in ascending order of NPC. In the present case, the two parameters solar radiation ((5.5,6,6.5) $\text{kWh/m}^2/\text{day}$) and diesel price (0.63, 0.7, 0.77, 0.84 and 0.91 ,0.98 and 1.05) are sensitive variables. The optimal system type, line graph, spider graph and surface plot are used to show sensitive results. In the Figure 11 below the net present cost of the most cost-effective result for specific set of solar radiations and diesel prices is obtained. At low and high solar radiation and low and high diesel price PV/diesel/battery system is cost effective system and become more favored.

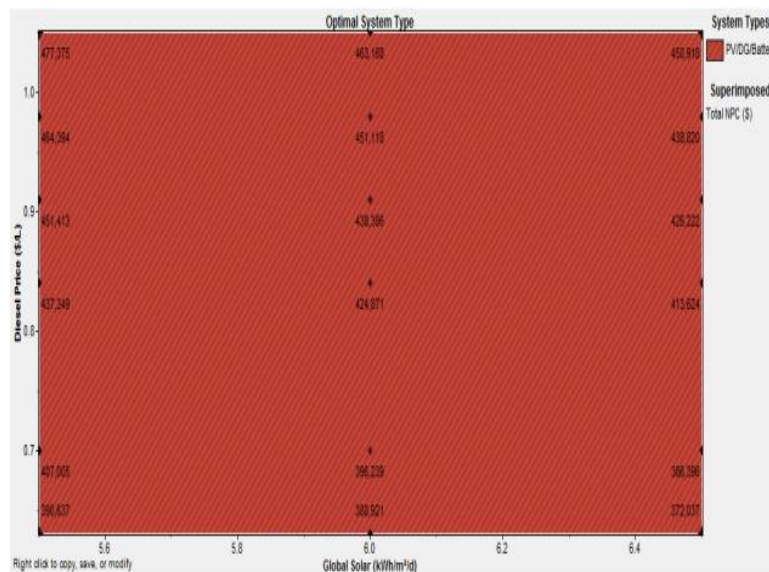

Figure 11: Sensitivity of solar radiation and DG price with total NPC labeled.

The surface plot for the Levelized COE is presented in Figure 12 global solar radiation is represented on the x-axis, and diesel price variation on the y-axis. As the global solar radiation increases, the power output from PV increases and consequently there is a reduction in the total NPC. As the total NPC reduces, the system's COE decreases as well. The same case happens for the diesel price but in reverse way, the total NPC and COE increases as the diesel price increases.

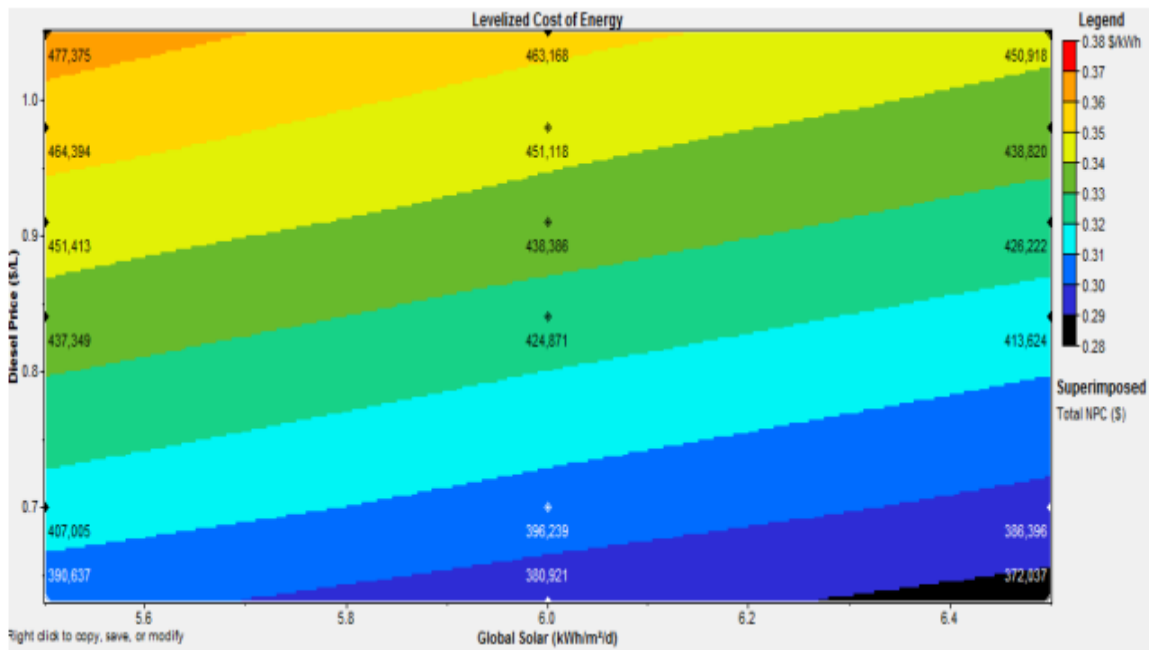

Figure 12: Surface plot of cost of electricity from HOMER.

The Figure 13 which shows how renewable fraction (RF) can be affected by global solar radiation, it is clear that RF increases with the increase of solar radiation and the variation of fuel price for the hybrid system.

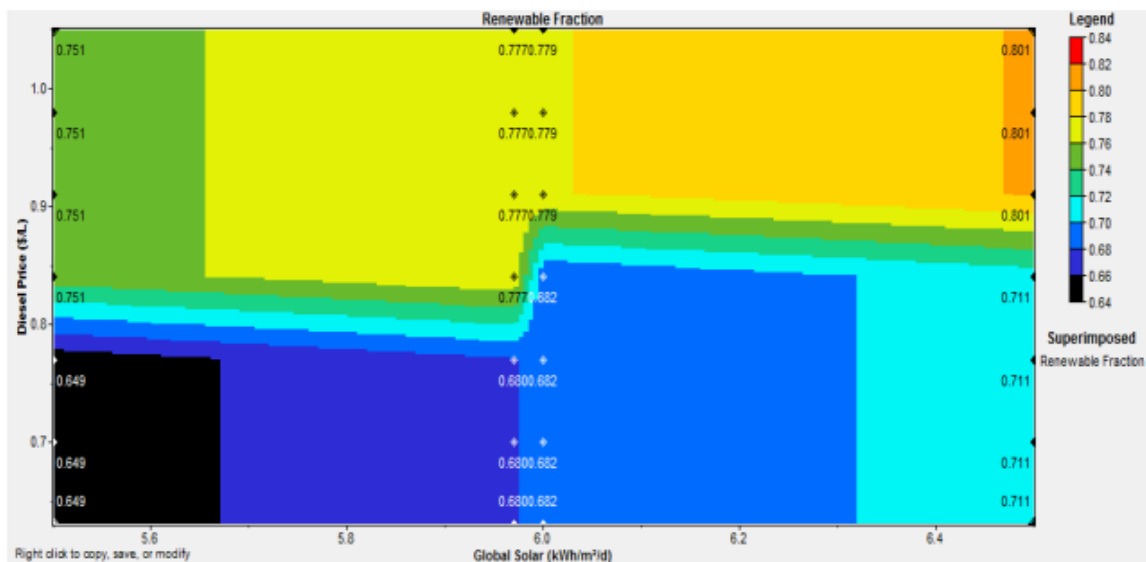

Figure 13: RF respect to global solar Radiation and Diesel price variation.

According to Figure 14 it can see that the LCOE decreases as the global solar radiation increases. The decrease in the COE for the variation in radiation in the range of 5.5 kwh/day – 6.5kwh/day is approximately \$0.02/kwh but it is not significant variation.

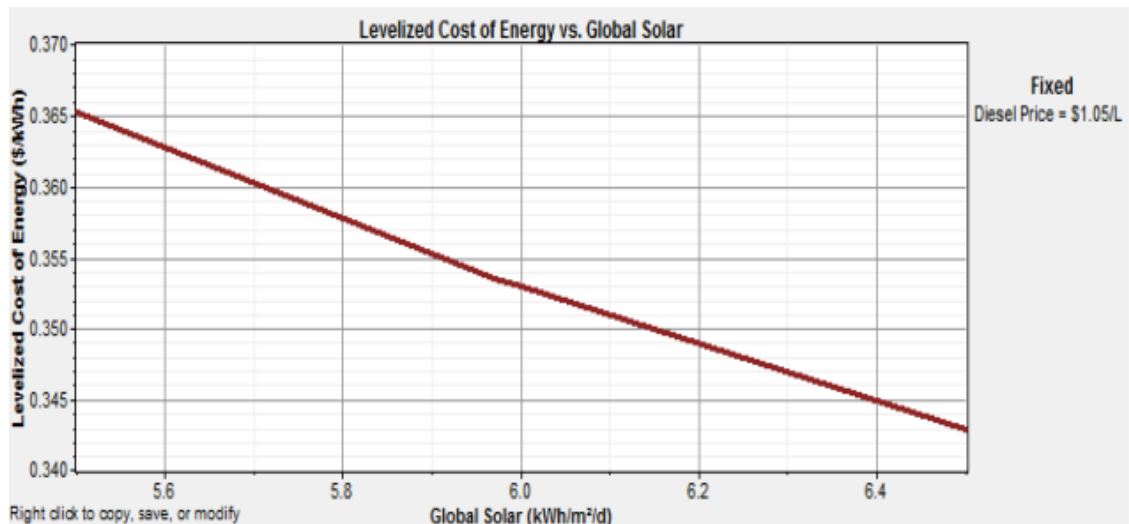

Figure 14: LCOE at different value of global solar radiation.

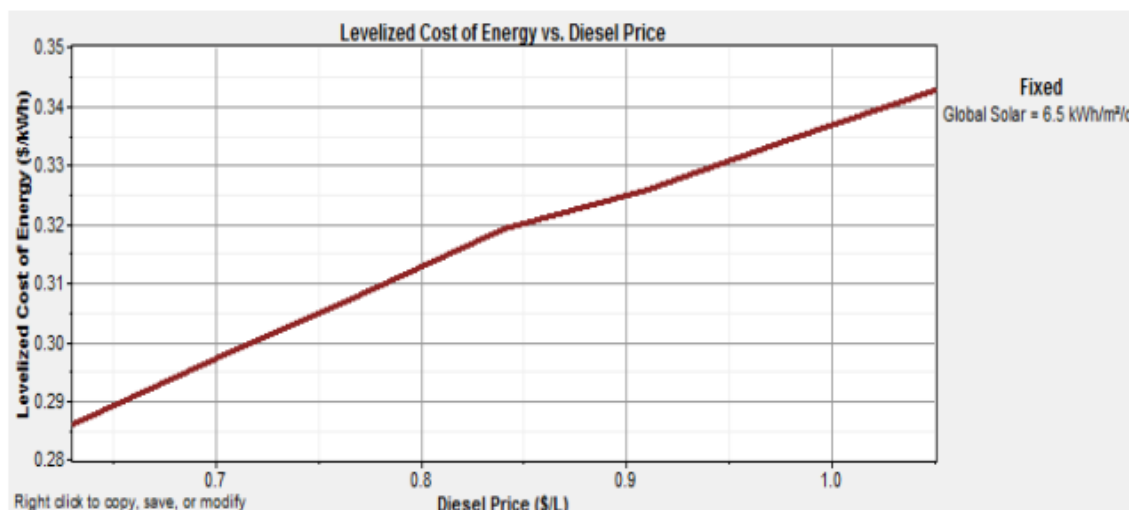

Figure 15: LCOE at different value of global solar radiation.

10 CONCLUSION

The main objective of this study is to find a best techno-economic of an off-grid power system supply a rural community in Dasaanach. In the design of PV/diesel generator/battery for rural community (Dasaanach), the study attains 5.97kWh/day as the average daily solar energy demand for a household with a total number of 834 households while the total average energy demand was about 325kWh per day. Off-grid renewable energy-based power systems cannot provide a continuous supply of electricity without a storage medium. Consequently, batteries are added to the hybrid system. In order to ensure uninterrupted power supply without putting severe stress on the battery bank for a reduced overall cost, a diesel generator is also incorporated. After selecting the appropriate components and studying their characteristics, the hybrid power system has been modeled using HOMER. Therefore,

simulations have been made to determine the best system which can supply the village load with the required level of availability. The usefulness cost of all hybrid structure that can satisfy the continuous load demand has been analyzed using HOMER software to determine the system which provides the lowest cost. A PV/diesel generator/ battery bank hybrid system has been found as the optimum system with capacities of 60 kW, 25k and 80 unit respectively.

11 Recommendation

Further investigations involve to be carried out to modify this thesis. To modify this thesis, the following recommendations are held.

- I. Afterward this study is deal to solve the electricity problem in the Dasaanach community found around Debub Omo Zone, other may work optimize this system for rural electrification as well by integrated with wind energy.
- II. Since this study use fixed trucking system but the use of MMPT solar tracking will increase generation efficiency of the solar panel.
- III. Addressing the possibility of replacing the diesel generator in the hybrid system by locally generated biofuels.
- IV. Integrating the standalone hybrid power systems with the national grid

12 REFERENCES

1. Odax Ugirimbabazi, "Analysis of Power System Options for Rural Electrification in Rwanda", University of Agder MSc. Thesis, 2015; 25.
2. Solomon Teklemichael, "Design and Analyzing of an Off-Grid Hybrid Renewable Energy System to Supply Electricity for Rural Areas (Case Study: Atsbi District, North Ethiopia)", KTH Industrial Engineering and Management, MSc. Thesis, Stockholm, 201.
3. Mutasim et al, "Prospect of Stand-Alone PV-Diesel Hybrid Power System for Rural Electrification In UAE", International journal of renewable energy research, 2014; 4: 3.
4. Terefe Jima," Simulation and Optimization of Wind Turbine, Solar PV, Storage Battery and Diesel Generator Hybrid Power System for a Cluster of Micro and Small Enterprises Working Wood and Metal Products at Welenchity Site", Addis Ababa University, MSc. Thesis, February, 2013.
5. K. Iromi udumaba Ranaweera, "techno-economic optimum sizing of hybrid renewable energy system Rural Electrification in Sri Lanka" University of Agder, MSc. Thesis, 2013.

6. Mahmoud Salah Ismail Abdel-Qader, "Simulation of a Hybrid Power System Consisting of Wind Turbine, PV, Storage Battery and Diesel Generator with Compensation Network: Design, Optimization and Economical Evaluation", at An-Najah National University, MSc. Thesis, Nablus, Palestine, 2008.
7. Getachew Bekele, "Study into The Potential and Feasibility of a Standalone Solar Winds Hybrid Electric Energy Supply System for Application in Ethiopia", KTH Industrial Engineering and Management, Doctoral thesis, Stockholm, December, 2009.
8. Gelma Boneya, "Design of Photovoltaic-Wind Hybrid Power Generation System for Ethiopian Remote Area", Addis Ababa University, MSc. Thesis, July, 2011.
9. Abiyot Makonnen, "Feasibility Study of Renewable Energy Resources for Electrification of Small Islands (A Case Study on Tana Lake Islands)", Addis Ababa University, MSc. Thesis, 2012.
10. John A. Duffie and William A. Beckman, "Solar Engineering of Thermal Processes", Solar Energy Laboratory University of Wisconsin-Madison, Fourth Edition.
11. AMRITA BHOWMIK, "Design and scheduling of a Hybrid Power System consisting of Wind Turbine, PV Generator, Battery Bank and Diesel Generator using 'area based observe and focus' algorithm", Jadavpur University, MSc. Thesis, 2013.
12. M.S. Ismail M. et al, "Design of PV/Diesel Stand Alone Hybrid System for A Remote Community in Palestine", Journal of Asian Scientific Research, 2(11): 599-606.
13. D. Tsuanyo, et al, "optimal design PV/Diesel Hybrid system for decentralized areas through economic criteria", International Journal of Computer, Electrical, Automation, Control and Information Engineering, 2015; 9: 2.
14. Abd El-Shafy et al, "Proposed Technique for Optimally Sizing a PV/Diesel Hybrid System", International Conference on Renewable Energies and Power Quality (ICREPQ10) Granada (Spain), 2010; 23: 25.
15. Yohannes Tesfaye, "Application of Micro-Hydro PV/Battery Off- Grid Hybrid Energy System for Ethiopian Rural Area", Addis Ababa University, MSc. Thesis, Aug, 2014.